



SWING KINGDOM TM **SK**
Let the fun begin!

— 2020 —

CONTENTS

PAGE

About Us Mission Statement	4
Frequently Asked Questions	5
Quality In Every Detail	6
The Difference	7
Playset Series Table of Contents	8-9
Kastle Series Intro	10
Double Tower Series Intro	28
Mountain Climber Series Intro	44
Playhouse Series Intro	62
Warrior Series Intro	80
Free Standing Items	86-87
Build Your Own Set	88
Accessories	89-99
Thank You	100
Warranty	101

Find us on the web. Post, tweet
or just tell us what you like!



**“My kids love this set!
It is built to last and we’ve already had tons of fun
playing on all the features. The quality construction
was well worth the price this far.”**

Alison Eberle



On The Cover: SK-30 Mega Mtn Climber



[Size: 24' Wide x 23' Deep x 14' High • **Weight:** 1,932 lbs.
• **Space Needed:** 36' Wide x 35' Deep • **Border Material:**
142' Landscape Timber • **Recommended Amount of
Mulch:** 6 Tons Rubber Mulch | 30 Cubic Yds. Wood Mulch
• **Overall Dimensions:** 24'w x 23'd x 14'h • **Color:** Wood
Grain PVC, Green Accents • **Tower:** 5' x 5' Mountain
Climber w/ Mega 7' Deck for MC • **Deck Height:** 5', 7' •
Access: MC Ladder w/ MC Hand Rail • **Roof:** (2) 5' x 10'
Canvas Roofs w/ Flags • **Climber:** Rock Wall for MC
Leg, Cargo Net for MC Leg • **Swing Beam:** 4 Position
Climber • **Slides:** 10' Avalanche Slide, 14' Avalanche
Slide, 7' Turbo Twister Slide • **Swings:** Trapeze, Dual
Rider, 3-Rope Tire Swing, Rubber Infant Swing,
Hammock Swing, Belt Swing • **Anchors:** 2 • **Fun
Items:** Steering Wheel, Megaphone, Telescope]

About Us

For loads of fun and family time, count on Swing Kingdom. A family operated manufacturer of premier vinyl swing sets, we strive to design and build fine quality, affordable swing sets perfect for children of all ages.

From the 500 square foot building where we started our business in 2000, to our new 43,000 square foot facility, Swing Kingdom has expanded to meet the growing demand for high quality, virtually maintenance-free swing sets. We were the first manufacturer to combine PVC and structural wood, along with stainless steel corner brackets and hardware for superior strength. Today, we continue to use only the finest quality materials to ensure safe, durable swing sets built to offer years of enjoyment.

Our playsets are loaded with activities that will spark every child's imagination and encourage daily physical activity and never-ending fun!



Our Mission:
To engage families in "Play"

FAQs

Q. Why vinyl?

A. Swing Kingdom's vinyl and decking products are the best and most uniform material available in the industry. Our vinyl is co-extruded under extreme pressure to assure a durable and beautiful finish for years to come.

Q. How strong is Swing Kingdom's vinyl?

A. Our vinyl has five times the tensile strength and four times the flexibility of wood. By combining the performance of vinyl with the sturdy characteristic of Wolmanized Natural Select outdoor wood, we create a swing set that is built to last.

Q. Will Swing Kingdom's vinyl turn yellow?

A. No. Our products contain an extremely effective UV inhibitor that offers more than enough protection from the sun's ultraviolet rays.

Q. Why do you cover the wood?

A. The wooden structural elements of your home are covered to preserve them and to reduce maintenance. The same philosophy is used for Swing Kingdom's vinyl play systems.

Q. Are Swing Kingdom's playsets easy to maintain?

A. Yes, very easy. If your playset does become dirty, you can easily revitalize its appearance with a simple garden hose, some glass cleaner and a soft bristled brush to wash dirt and debris away.

Q. Are surface checks and cracks or knotty appearances normal?

A. No. Your swing set will have a clean and smooth finish for years to come.

Q. Does my installation site need to be perfectly level?

A. No. Your installation site does not need to be perfectly level. We ask that the site be fairly flat or level. Our Swing Kingdom crew can perform leveling of 6" or less if needed. If you are not sure if your site is level enough prior to installation, then please contact our scheduling department to discuss.

Q. What type of access is needed for installation?

A. Different playsets have different access requirements. Larger playsets require more open access, while smaller playsets might be able to fit through standard size gate openings. Not having fencing or having a clear path from the unloading point to the installation site is ideal. If access would be an issue, then your playset could be built onsite in your yard. Someone from the Swing Kingdom scheduling department will discuss access details with you when they call to confirm delivery and installation of your playset.

Q. How long will my playset installation take?

A. The installation time for a playset varies according to the size and complexity of it. The average residential playset takes about 2 to 3 hours to complete the installation. A more accurate installation time can be obtained when discussing with the Swing Kingdom scheduling department.



Quality In Every Detail

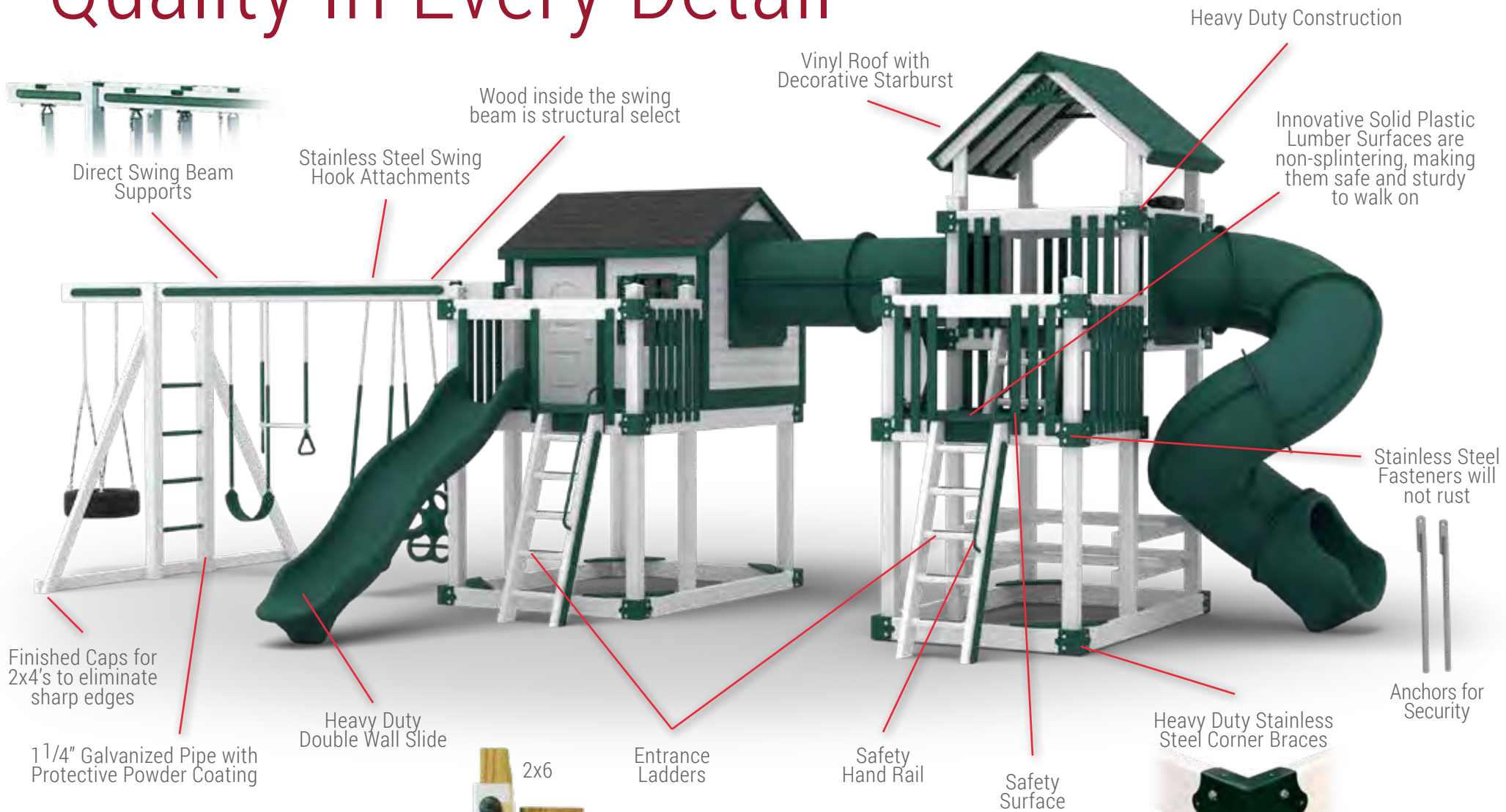

Heavy Duty Construction

All structural members are preserved wood encased with almond, white, or wood grain vinyl. All of our play systems are built with the finest materials available.



Color Options



Almond & Green



Almond, Yellow & Red



Wood Grain & Green Premium



White & Green



White & Blue



Wood Grain & Red Premium

The Difference

Durability - There is simply no other playset that comes close to the durability of Swing Kingdom vinyl playsets. I like to tell folks that I've personally been selling these sets for over 15 years, and I haven't seen one wear out yet - so as far as we know, they may last forever! Also, PVC is something they bury in the ground and it lasts for 50+ years, so even if it lasts only half that long above ground, you've got a pretty durable set.

Design - Most other playset brands generally have pre-configured models to choose from. One of the benefits of our product is not only do we utilize a modular design, which allows a variety of options to be placed in different locations, but we have a 3D Design Center to help customers design and visualize the perfect set for their particular needs and budget.

Service - I often tell customers that warranty claims against these sets are quite rare, as they just don't break. And in the case that they do, Swing Kingdom is very good about standing behind their warranty - and in some cases, even going beyond the call of duty and replacing components that were outside of warranty."

- Kyle Wenger
Amish Direct Playsets

"Paying a little more upfront, is well worth it in the long run when considering the ongoing maintenance costs of cedar solutions and how an SK vinyl play set holds its value over time. Most customers are able to resell their playset after 10 years for about half of what they originally paid for it.

Every playset is made-to-order, so you are not paying a customization fee. You can truly make your playset unique to your needs and budget.

Safety is always of the utmost concern with every customized playset. The experts at SK are always looking out for your well-being."

- Tom Rosenecker
American Eagle Fireplace & Playsets

"It is rare that your expectations are exceeded rather than satisfied. Swing Kingdom provides that experience in backyard playsets for your whole family to enjoy. If you can dream it, they can create it and those childhood memories last a lifetime!"

Swingset Warehouse • New Jersey





Kastle Tower Series

Having fun is as simple as stepping out the back door. With an assortment of swings, slides and more, the Kastle Tower Series is great for nearly any size backyard.



A-1 Standard Climber
page 12-13



A-3 Deluxe
page 14-15



A-4 Special
page 16-17



A-5 Deluxe
page 18-19



KC-1 Clubhouse
page 20-21



KC-3 Deluxe
page 22-23



KC-7 Deluxe
page 24-25



KC-10 Economy Turbo
page 26-27



Double Tower Series

With covered lookouts and tons of ways to play, the Double Tower Series brings great style to the backyard and twice the fun for everyone!



A-7 Deluxe
page 30-31



KTB-2 Turbo Tower
page 32-33



RL-1 Adventure
page 34-35



RL-3 Sports Tower
page 36-37



RL-4 Super Tower
page 38-39



RL-10 Cliff Lookout
page 40-41



KRC Extreme
page 42-43

Warrior Climbing Series

Want to be the next Fitness Warrior?
You will need to train like one.



KC-8 Fitness Tower
page 82-83



RL-20 Fitness Adventure
page 84-85



Mountain Climber Series

For large, active families the Mountain Climber Series includes fun climbing elements for an easy way to increase exercise and enjoyment for children of all ages.



Playhouse Series

With room to let imaginations grow, the Playhouse Series gives children swings, slides, and a very special place to call their own. The Playhouse Series is ideal for creative children with active imaginations and families of all sizes. Enjoy a world of make-believe that makes every day different and fun with one of our outdoor playsets!



SK-3 Mtn. Climber
page 46-47



SK-5 Mtn. Climber
page 48-49



SK-10 Mtn. Climber
page 50-51



C-1 Hideout
page 64-65



C-2 Turbo Escape
page 66-67



C-3 Tunnel Escape
page 68-69



SK-15 Mtn. Climber
page 52-53



SK-18 Mtn. Climber
page 54-55



SK-30 Mega Mtn. Climber
page 56-57



C-4 Hideout
page 70-71



C-5 Castle
page 72-73



C-8 Bridge Escape
page 74-75



SK-40 Rocky Mtn. Climber
page 58-59



SK-45 Retreat Climber
page 60-61



C-10 Hideout
page 76-77



SK-60 Cottage Escape
page 78-79



KASTLE TOWER SERIES



“The Kastle Tower playsets are a customer favorite because of their compact size and price point. But no worries, there is no compromising the fun that these sets will bring to your family!”

Brooke Stuart, Warranty Claims Specialist / CSR

Having fun is as simple as stepping out the back door.

With an assortment of swings, slides and more, the Kastle Tower Series of children’s playsets are great for nearly any backyard, even small ones, which can be built onto in the future as your family and children grow.



A-1 Standard Climber



Size:

15' Wide x 14' Deep x 8' High

Weight:

486 lbs.

Space Needed:

27' Wide x 26' Deep

Border Material:

106' Landscape Timber

Recommended Amount of Mulch:

3 Tons Rubber Mulch

12 Cubic Yds. Wood Mulch

Overall Dimensions:

15'w x 14'd x 8'h

Color: White PVC, Green Accents

Tower: 2' x 2' Tower

Deck Height: 5'

Access: Rung Climber,
Flat Step Access Ladder
w/ Access Railing

Slide: 10' Waterfall Slide

Swing Beam: 3 Position Climber

Swings: Belt Swing, Baby Swing,
Trapeze

Anchors: 4

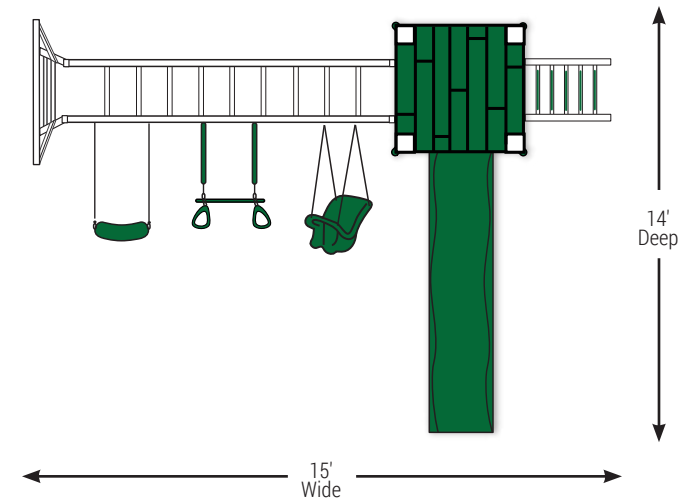



A-3 Deluxe



Size:

22' Wide x 9' Deep x 12' High

Weight:

982 lbs.

Space Needed:

34' Wide x 21' Deep

Border Material:

110' Landscape Timber

Recommended Amount of Mulch:

3 Tons Rubber Mulch

14 Cubic Yds. Wood Mulch

Overall Dimensions:

22'w x 9'd x 12'h

Color: White PVC, Blue Accents

Tower: 3' x 5' Tower

Deck Height: 5'

Access: Flat Step Access Ladder
w/ Access Railing

Roof: 3' x 8' Canvas Roof w/ Flags

Slide: 10' Waterfall Slide

Swing Beam: 3 Position Single Beam

Swings: Belt Swing, Trapeze,
Rubber Infant Swing

Anchors: 2

Fun Items: Ship's Wheel

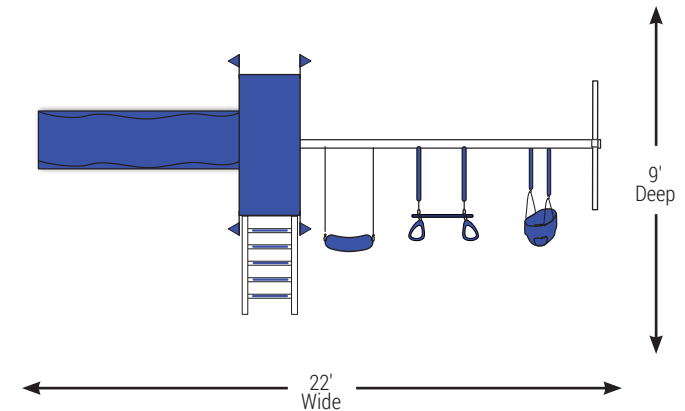



A-4 Special



Size:

15' Wide x 15' Deep x 12' High

Weight:

721 lbs.

Space Needed:

27' Wide x 27' Deep

Border Material:

108' Landscape Timber

Recommended Amount of Mulch:

3 Tons Rubber Mulch

14 Cubic Yds. Wood Mulch

Overall Dimensions:

15'w x 15'd x 12'h

Color: Almond PVC,
Red & Yellow Accents

Tower: 4' x 4' Tower

Deck Height: 5'

Access: Flat Step Access Ladder
w/ Access Railing

Roof: Gable Roof

Slide: 10' Avalanche Slide

Swings: Belt Swing, Rubber Infant
Swing, Dual Rider
w/ 4-Point Swing Adapter

Swings Beam: 3 Position Single Beam

Anchors: 2

Fun Items: Binoculars

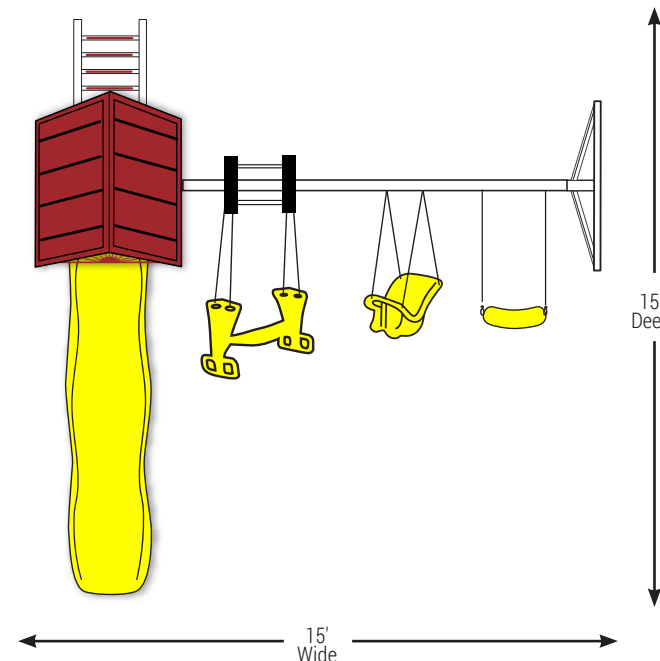



A-5 Deluxe



Size:

21' Wide x 15' Deep x 12' High

Weight:

928 lbs.

Space Needed:

33' Wide x 27' Deep

Border Material:

120' Landscape Timber

Recommended Amount of Mulch:

4 Tons Rubber Mulch

17 Cubic Yds. Wood Mulch

Overall Dimensions:

21'w x 15'd x 12'h

Color: Almond PVC, Green Accents

Tower: 4' x 4' Tower

Deck Height: 5'

Access: Flat Step Access Ladder
w/ Access Railing

Roof: 4' x 4' Vinyl Roof

Climber: 3' x 5' Rockwall w/ Rope

Slide: 10' Avalanche Slide

Swing Beam: 4 Position Single Beam

Swings: Belt Swing, Baby Swing,
Trapeze, 4-Rope Tire Swing

Anchors: 2

Fun Items: Steering Wheel, Telescope

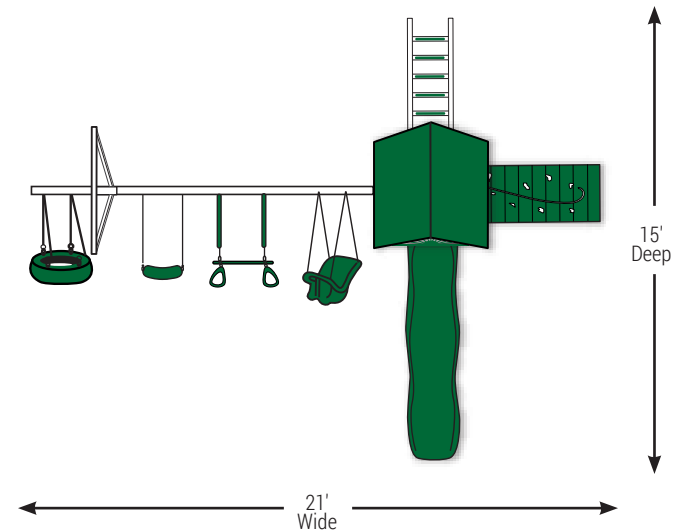



KC-1 Clubhouse



Size:

12' Wide x 14' Deep x 12' High

Weight:

1,012 lbs.

Space Needed:

24' Wide x 26' Deep

Border Material:

100' Landscape Timber

Recommended Amount of Mulch:

3 Tons Rubber Mulch

14 Cubic Yds. Wood Mulch

Overall Dimensions:

12'w x 14'd x 12'h

Color: Almond PVC, Green Accents

Tower: 5' x 5' Tower

Deck Height: 5'

Access: Flat Step Access Ladder
w/ Access Railing

Roof: Gable Roof

Slide: 10' Avalanche Slide

Swing Beam: 2 Position Extension Arm

Swings: Belt Swing, Baby Swing

Anchors: 2

Fun Items: (25 sq. ft.) Clubhouse
Decking, (20 linear ft.)
Clubhouse Walls 5' high,
Ship's Wheel, Binoculars

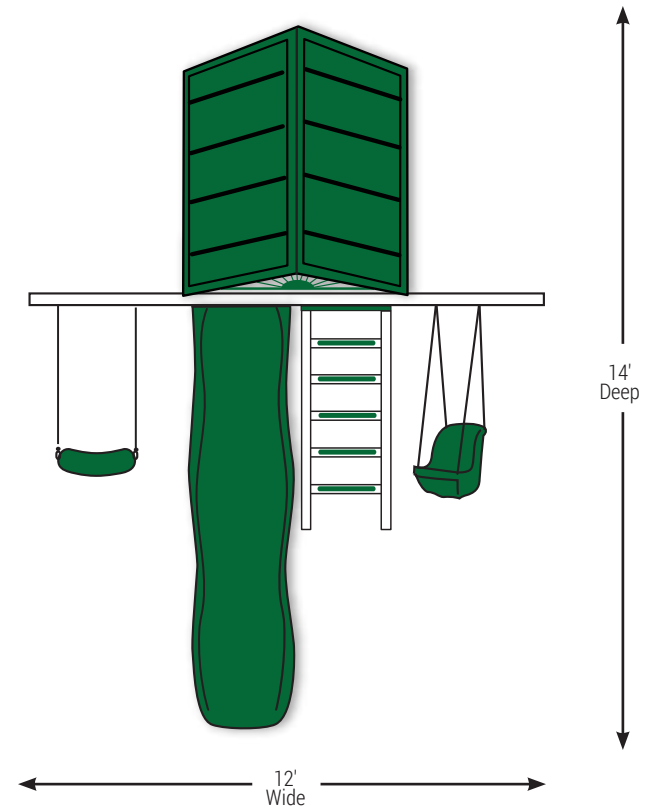



KC-3 Deluxe



Size:

16' Wide x 16' Deep x 13' High

Weight:

1,040 lbs.

Space Needed:

28' Wide x 28' Deep

Border Material:

112' Landscape Timber

Recommended Amount of Mulch:

3 Tons Rubber Mulch

15 Cubic Yds. Wood Mulch

Overall Dimensions:

16'w x 16'd x 13'h

Color: White PVC, Blue Accents

Tower: 5' x 5' Tower

Deck Height: 5'

Access: Flat Step Access Ladder
w/ Access Railing

Roof: 5' x 10' Canvas Roof w/ Flags

Slide: 10' Waterfall Slide

Swing Beam: 3 Position Single Beam

Swings: (2) Belt Swings, Trapeze

Anchors: 2

Fun Items: Ship's Wheel, Telescope

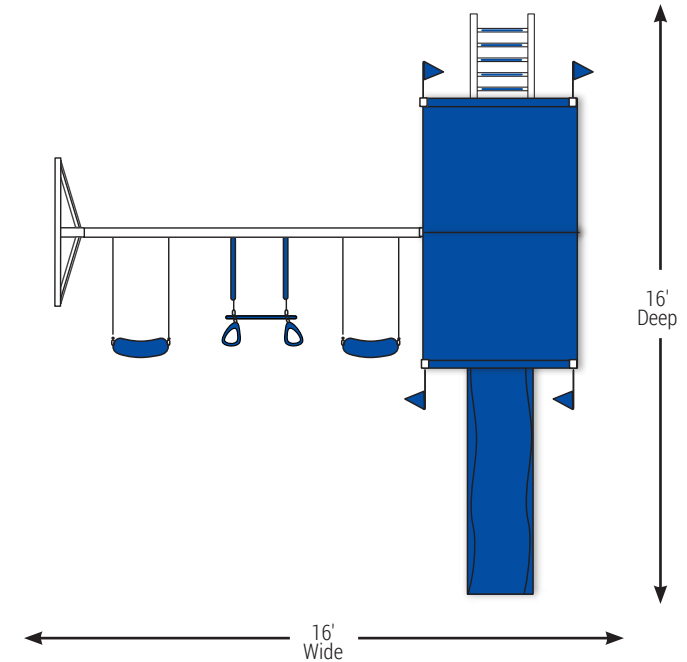



KC-7 Deluxe



Size:

18' Wide x 16' Deep x 13' High

Weight:

1,098 lbs.

Space Needed:

30' Wide x 28' Deep

Border Material:

116' Landscape Timber

Recommended Amount of Mulch:

3 Tons Rubber Mulch

17 Cubic Yds. Wood Mulch

Overall Dimensions:

18'w x 16'd x 13'h

Color: White PVC, Blue Accents

Tower: 5' x 5' Tower

Deck Height: 5'

Access: Flat Step Access Ladder
w/ Access Railing

Roof: 5' x 10' Canvas Roof w/ Flags

Slides: (2) 10' Avalanche Slides

Swing Beam: 3 Position Single Beam

Swings: Belt Swing, Rubber Infant
Swing, Dual Rider
w/ 4-Point Swing Adapter

Anchors: 2

Fun Items: Bubble Panel, 2' x 5'
Lemonade Stand,
Ship's Wheel, Megaphone

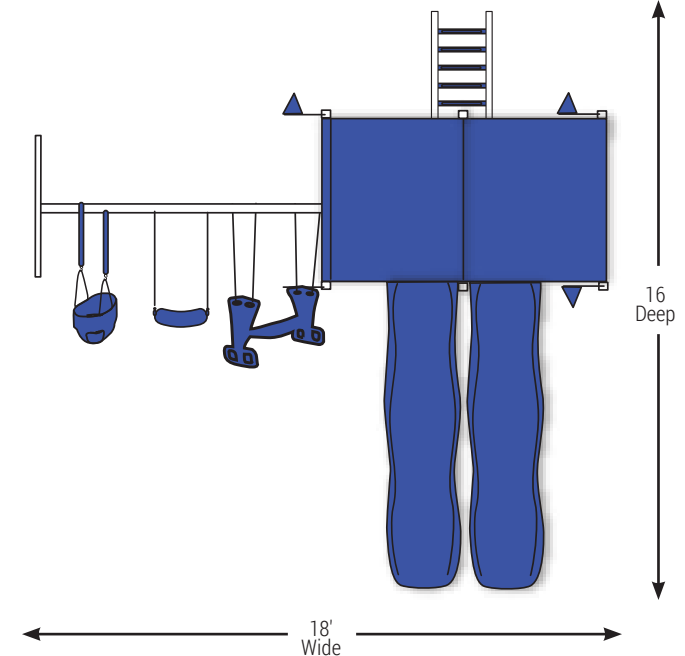



KC-10 Economy Turbo



Size:

25' Wide x 16' Deep x 12'-6" High

Weight:

1,175 lbs.

Space Needed:

37' Wide x 28' Deep

Border Material:

130' Landscape Timber

Recommended Amount of Mulch:

4 Tons Rubber Mulch

20 Cubic Yds. Wood Mulch

Overall Dimensions:

25'w x 16'd x 12'-6"h

Color: White PVC, Blue Accents

Tower: 5' x 5' Tower w/ 7' Landing

Deck Height: 5' w/ 7' Landing

Access: Flat Step Access Ladder
w/ Access Railing

Roof: 5' x 5' Pyramid Roof

Slides: 10' Waterfall Slide,
7' Turbo Twister Slide

Swing Beam: 4 Position Single Beam

Swings: Belt Swing, Trapeze,
Cyclone Disc, Baby Swing

Anchors: 2

Fun Items: Binoculars

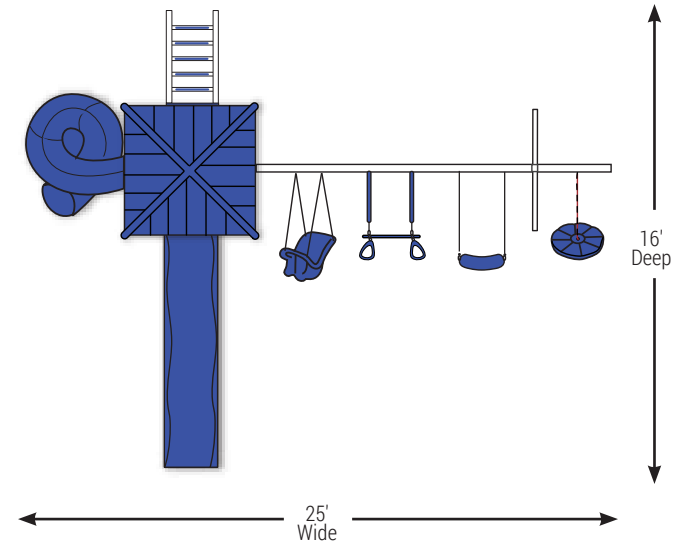



DOUBLE TOWER SERIES



“Double towers mean double the fun! This Swing Kingdom playset series is very unique and provides multi-level platforms to explore. I also like that some of the double tower playsets offer sports components to help children develop motor skills and coordination while enjoying hours of fun.”

Dave Kmiecik, Scheduler

Non-stop action begins the minute they run out the door.

With covered lookouts and tons of ways to play, the Double Tower Series brings great style to the backyard and doubles the fun for everyone! This series of outdoor playsets is ideal for multiple children of all ages with many ways to let their imaginations soar.



A-7 Deluxe



Size: 23' Wide x 21' Deep x 11' High
Weight: 1,758 lbs.

Space Needed: 35' Wide x 33' Deep
Border Material: 136' Landscape Timber

Recommended Amount of Mulch:
5 Tons Rubber Mulch | 20 Cubic Yds. Wood Mulch



Overall Dimensions:

23'w x 21'd x 11'h

Color: White PVC, Green Accents

Tower: (2) 4' x 4' Towers

Deck Height: (2) 5'

Access: (2) Flat Step Access Ladders
w/ Access Railings

Roof: (2) 4' x 4' Pyramid Roofs

Connector: 8' Bridge w/ Rope

Slide: 5' Turbo Twister Slide

Swing Beam: 4 Position Climber

Swings: Belt Swing, Trapeze,
Rubber Infant Swing, Uni Rider

Anchors: 2

Fun Items: Bubble Panel, Ship's Wheel,
4' x 4' Picnic Table, Binoculars

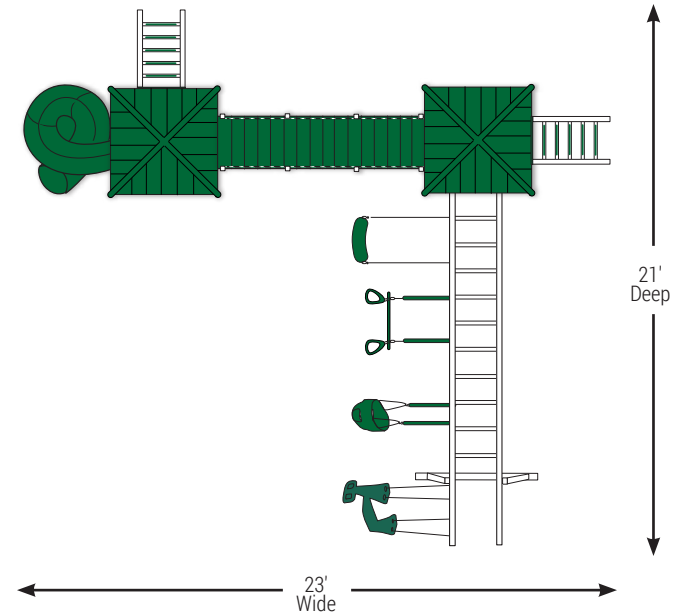



KTB-2 Turbo Tower



Size:

20' Wide x 14' Deep x 13' High

Weight:

1,653 lbs.

Space Needed:

32' Wide x 26' Deep

Border Material:

116' Landscape Timber

Recommended Amount of Mulch:

4 Tons Rubber Mulch

20 Cubic Yds. Wood Mulch

Overall Dimensions:

20'w x 14'd x 13'h

Color: Almond, Red & Yellow Accents

Tower: 4' x 8' Double Tower

Deck Height: 5', 7'

Access: Flat Step Access Ladder
w/ Access Railing

Roof: 4' x 4' Vinyl Roof

Climber: 3' x 7' Rock Wall w/ Rope

Slide: 7' Turbo Twister Slide

Swing Beam: 3 Position Single Beam

Swings: (2) Belt Swings, Baby Swing

Anchors: 2

Fun Items: Steering Wheel, Binoculars

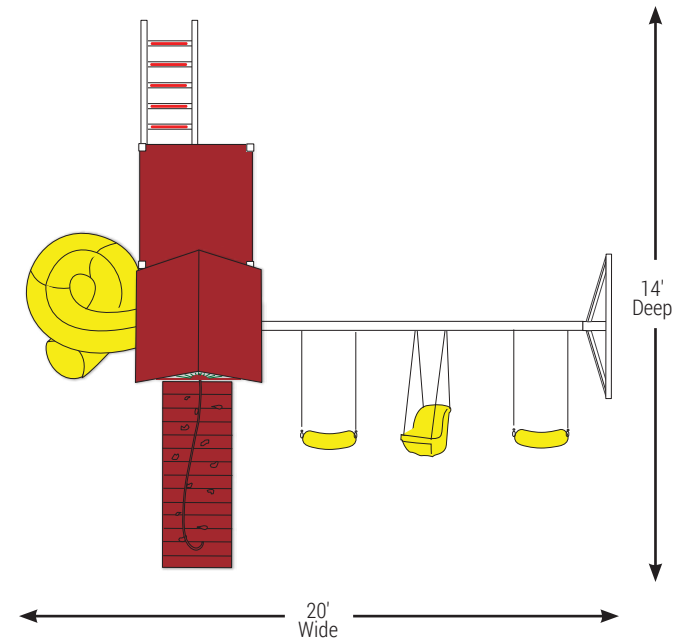

RL-1 Adventure



Size: 32' Wide x 29' Deep x 13' High
Weight: 3,191 lbs.

Space Needed: 44' Wide x 41' Deep
Border Material: 170' Landscape Timber

Recommended Amount of Mulch:
9 Tons Rubber Mulch | 40 Cubic Yds. Wood Mulch



Overall Dimensions:

32'w x 29'd x 13'h

Color: White PVC, Blue Accents

Tower: (2) 5' x 9' Double Towers

Deck Height: (2) 5', (2) 7'

Access: (2) Flat Step Access Ladders
w/ Access Railings

Roof: (2) Gable Roofs

Connector: 6'-6" Castle Design Bridge

Climber: 3' x 7' Rock Wall w/ Rope

Slides: 10' Avalanche Slide, 14' Avalanche
Slide, 7' Turbo Twister Slide

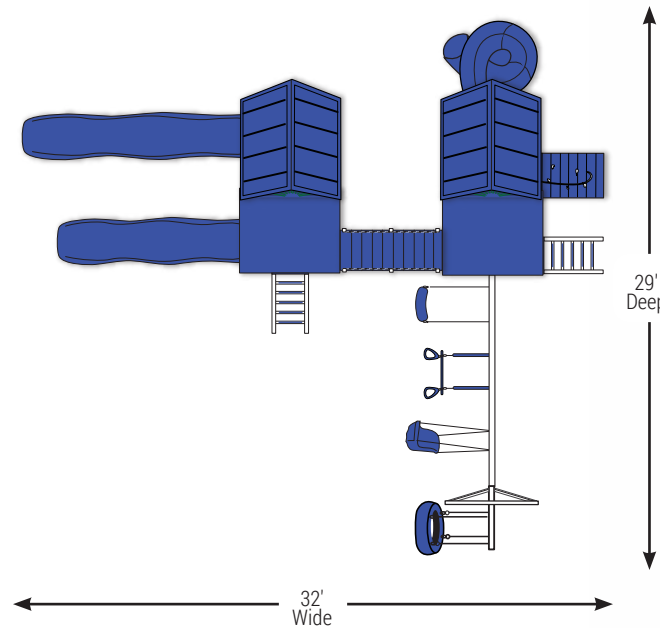

Swing Beam: 4 Position Single Beam

Swings: Belt Swing, Trapeze, Baby Swing,
4-Rope Tire Swing

Anchors: 2

Fun Items: Bubble Tunnel, Binoculars,
Ship's Wheel, Spotlight,
2' x 5' Lemonade Stand





RL-3 Sports Tower



Size:

31' Wide x 20' Deep x 13' High

Weight:

1,950 lbs

Space Needed:

43' Wide x 32' Deep

Border Material:

150' Landscape Timber

Recommended Amount of Mulch:

5 Tons Rubber Mulch

30 Cubic Yds. Wood Mulch

Overall Dimensions:

31'w x 20'd x 13'h

Weight: 1,950 lbs.

Color: Almond, Red & Yellow Accents

Tower: 5' x 9' Double Tower

Deck Heights: 5', 7'

Access: Flat Step Access Ladder
w/ Access Railing

Roof: 5' x 5' Vinyl Roof

Slides: 14' Avalanche Slide,
7' Turbo Twister Slide

Swing Beam: 4 Position Single High
Beam

Swings: (2) Belt Swings, Trapeze

Anchors: 2

Fun Items: Buzzer Beater Hoops,
QB Challenge, 5' x 5' Picnic
Table, Megaphone

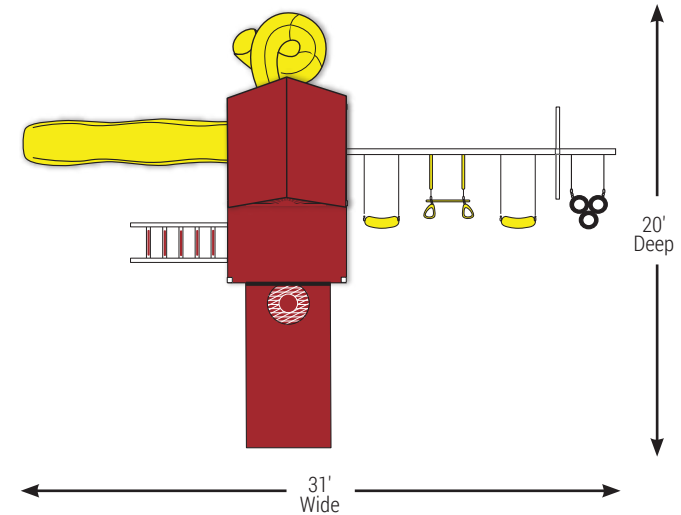



RL-4 Super Tower



Size:

31' Wide x 13' Deep x 13' 6" High

Weight:

1,682 lbs

Space Needed:

43' Wide x 25' Deep

Border Material:

136' Landscape Timber

Recommended Amount of Mulch:

6 Tons Rubber Mulch

25 Cubic Yds. Wood Mulch

Overall Dimensions:

31'w x 13'd x 13' 6"h

Color: White PVC, Blue Accents

Tower: 5x9 Double Tower

Deck Height: 5', 7'

Access: Flat Step Access Ladder
w/ Access Railing

Roof: 5' x 5' Vinyl

Climber: 3' x 5' Rockwall w/ Rope

Slide: 14' Avalanche Slide

Swing Beam: 4 Position Climber
Beam

Swings: (2) Belt Swings,
Rubber Infant Swing,
4 Rope Tire Swing

Anchors: 2

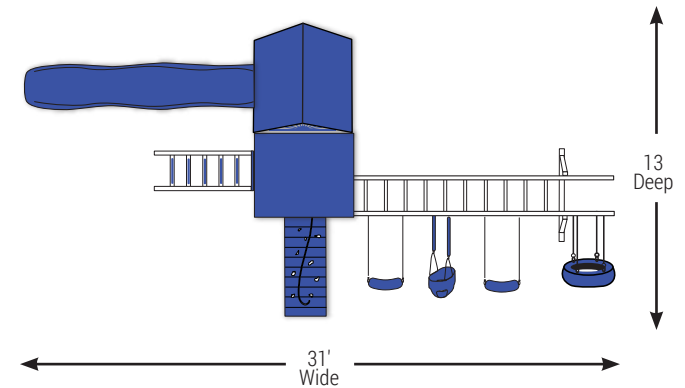



RL-10 Cliff Lookout



Size:

30' Wide x 24' Deep x 16' High

Weight:

2,432 lbs.

Space Needed:

42' Wide x 36' Deep

Border Material:

156' Landscape Timber

Recommended Amount of Mulch:

10 Tons Rubber Mulch

50 Cubic Yds. Wood Mulch

Overall Dimensions:

30'w x 24'd x 16'h

Color: Almond PVC, Red & Yellow Accents

Tower: 5' x 9' Double Tower
w/ Jungle Bar Tower

Deck Height: 5', 7', 9'

Access: 12' Ramp w/ Rope

Roof: (2) Gable Roofs

Climber: 5' Rock Wall w/ Rope

Slides: 14' Avalanche Slide,
9' Tunnel Express Slide

Swing Beam: 3 Position High Single
Beam

Swings: (2) Belt Swings, Trapeze

Anchors: 2

Fun Items: (25 sq. ft.) Clubhouse
Decking, Spotlight, Telescope,
Binoculars, 7' Fire Pole,
Steering Wheel, Bubble Panel,
(20 Linear ft.) Clubhouse
Walls 7' high, 4' x 5' Picnic
Table, Tic-Tac-Toe

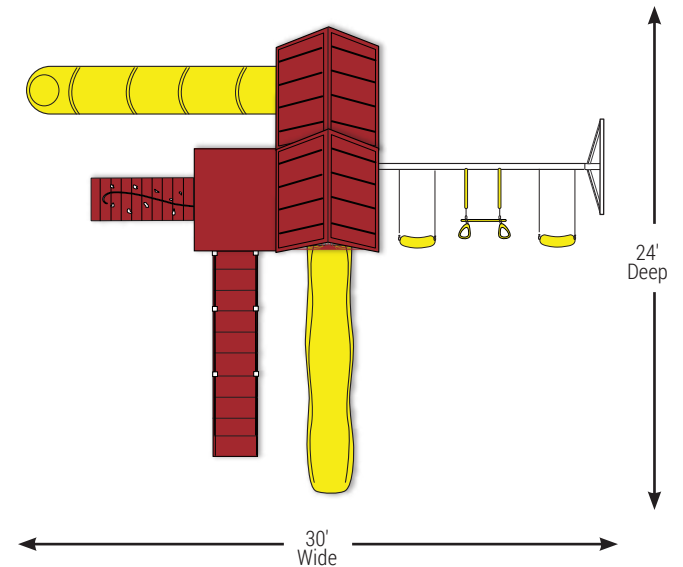

KRC Extreme



Size: 44' Wide x 44' Deep x 16' High
Weight: 5,641 lbs.

Space Needed: 56' Wide x 56' Deep
Border Material: 224' Landscape Timber

Recommended Amount of Mulch:
15 Tons Rubber Mulch | 75 Cubic Yds. Wood Mulch



Overall Dimensions:

44'w x 44'd x 16'h

Color: White PVC, Green Accents

Weight: 5,641 lbs.

Tower 1: 5' x 5' Mountain Climber
w/Mega 7' Deck for MC

Deck Height: 5', 7'

Access: MC Ladder w/ MC Hand Rail

Roof: (2) 5' x 10' Canvas Roofs w/ Flags

Climber: Rock Wall for MC Leg,
Cargo Net for MC Leg

Tower 2: 5' x 9' Double Tower

Deck Height: 5', 7'

Access: Flat Step Access Ladder
w/ Access Railing

Roof: Gable Roof

Climber: 3' x 7' Rock Wall w/ Rope,
4' x 5' Cargo Net

Tower 3: 5' x 9' Double Tower
w/ Jungle Bar Tower

Deck Height: 5', 7', 9'

Access: 12' Ramp w/ Rope

Roof: (2) Gable Roofs

Connector: 6'-6" Tower Tunnel,
8' Bridge w/ Rope

Slides: 14' Avalanche Slide, 10' Avalanche
Slide, 7' Turbo Twister Slide

Swing Beam: 4 Position Climber,
3 Position High Single Beam

Swings: (3) Belt Swings, (2) Trapeze,
Baby Swing, Hammock Swing,
Dual Rider, 3-Rope Tire Swing

Anchors: 4

Fun Items: Bubble Panel, Tic Tac Toe,
Ship's Wheel, (2) Binoculars,
5' Fire Pole, Megaphone,
Telescope, (25 sq. ft.) Clubhouse
Decking, (20 linear ft.) Clubhouse
Walls 7' high, Steering Wheel,
4' x 5' Picnic Table

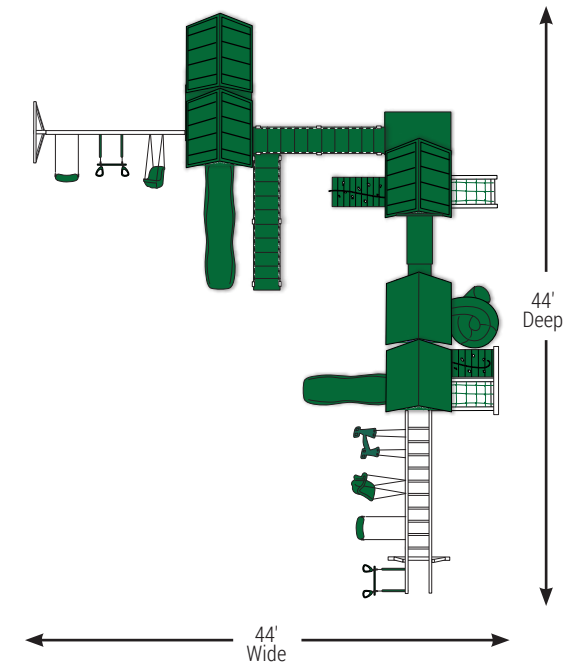



MOUNTAIN CLIMBER SERIES

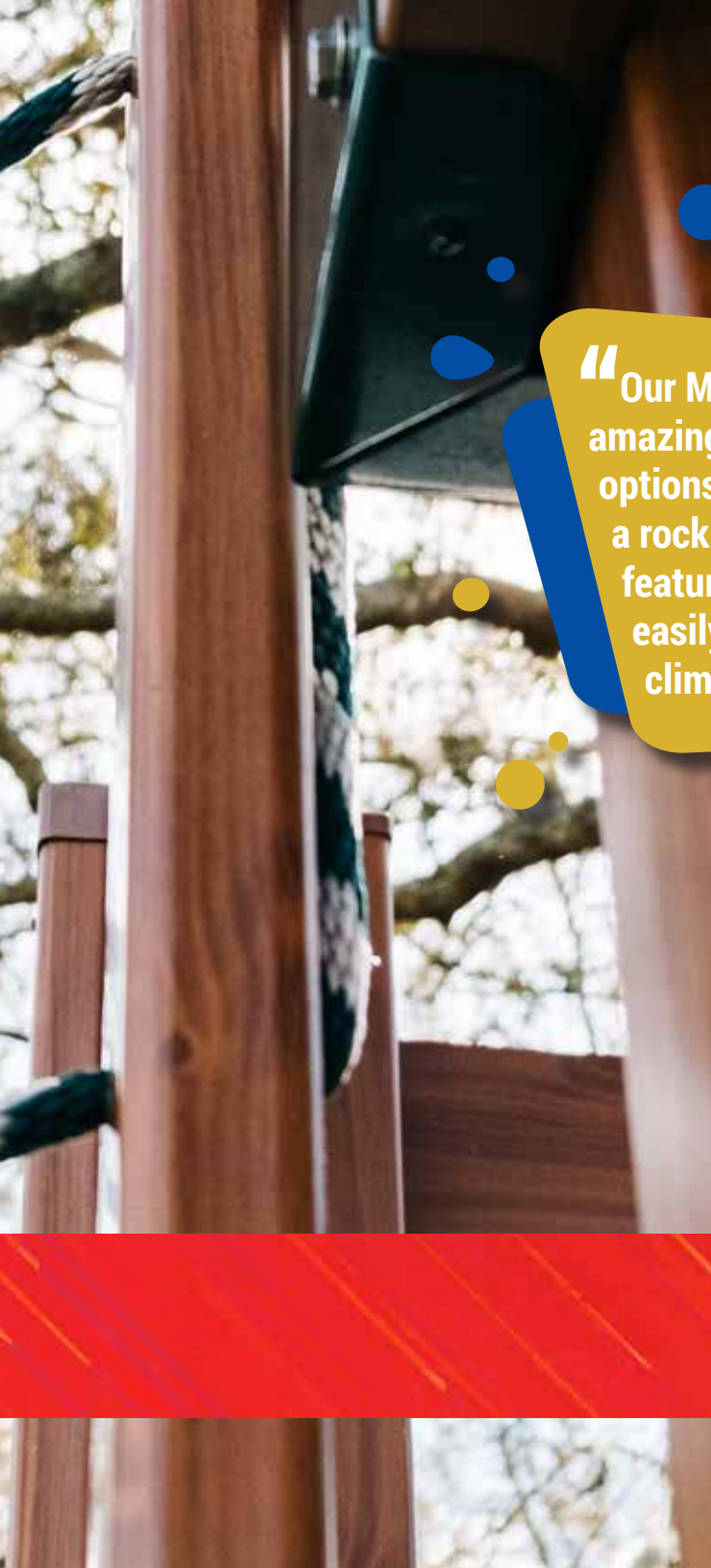

“Our Mountain Climber Series is amazing because it includes so many options for children to be active, including a rock wall, cargo net, slides, swings, and more. Another amazing feature of the Mountain Climber Series is its versatility; it can easily be designed for a small family as well as a large one. Let the climbing fun begin!”

Beve Robbins, Lead Designer / Order Processor

Turn an ordinary day into an extraordinary adventure!

For large, active families, the Mountain Climber Series includes fun climbing elements for an easy way to increase exercise and enjoyment for children of all ages. Climb, slide, swing, and glide. The Mountain Climber Series has something for everyone.



SK-3 Mountain Climber



Size:

19' Wide x 12' Deep x 11' High

Weight:

789 lbs.

Space Needed:

31' Wide x 24' Deep

Border Material:

110' Landscape Timber

Recommended Amount of Mulch:

3 Tons Rubber Mulch

12 Cubic Yds. Wood Mulch

Overall Dimensions:

19'w x 12'd x 11'h

Color: White PVC, Green Accents

Tower: 3' x 5' Mountain Climber

Deck Height: 5'

Access: MC Ladder w/ MC Hand Rail

Roof: 3' X 8' Canvas w/ Flags

Climber: Rock Wall for MC Leg

Slide: 10' Avalanche Slide

Swing Beam: 2 Position Single Beam,
1 Side Extension Arm

Swings: Belt Swing, Trapeze, Baby
Swing, 3-Rope Tire Swing

Anchors: 2

Fun Items: Steering Wheel, Telescope

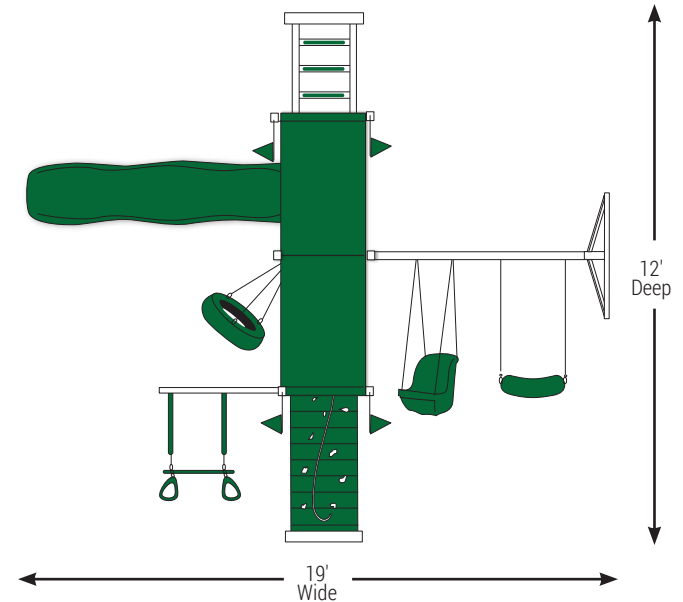



SK-5 Mountain Climber



Size:

12' Wide x 18' Deep x 12' High

Weight:

1,162 lbs.

Space Needed:

24' Wide x 30' Deep

Border Material:

108' Landscape Timber

Recommended Amount of Mulch:

3 Tons Rubber Mulch

12 Cubic Yds. Wood Mulch

Overall Dimensions:

12'w x 18'd x 12'h

Color: Almond PVC, Green Accents

Tower: 5' x 5' Mountain Climber

Deck Height: 5'

Access: MC Ladder w/ MC Hand Rail

Roof: 5' x 10' Canvas Roof w/ Flags

Climber: Rock Wall for MC Leg, Cargo Net for MC Leg

Slide: 10' Waterfall Slide

Swing Beam: 2 Position Extension Arm

Swings: Belt Swing, Trapeze, 3-Rope Tire Swing

Anchors: 4

Fun Items: Telescope, Steering Wheel

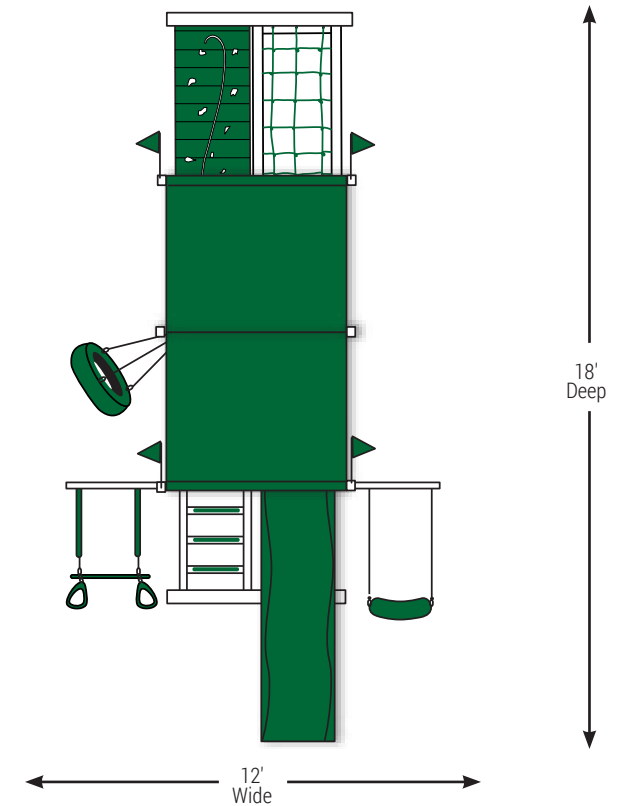



SK-10 Mountain Climber



Size:

16' Wide x 18' Deep x 12' High

Weight:

1,162 lbs.

Space Needed:

28' Wide x 30' Deep

Border Material:

116' Landscape Timber

Recommended Amount of Mulch:

3 Tons Rubber Mulch

17 Cubic Yds. Wood Mulch

Overall Dimensions:

16'w x 18'd x 12'h

Color: White PVC, Blue Accents

Tower: 5' x 5' Mountain Climber

Deck Height: 5'

Access: MC Ladder w/ MC Hand Rail

Roof: 5' x 10' Canvas Roof w/ Flags

Climber: Rock Wall for MC Leg,
Cargo Net for MC Leg

Slide: 10' Avalanche Slide

Swing Beam: 2 Position Climber, 1
Position Extension Arm

Swings: Belt Swing, Trapeze,
3-Rope Tire Swing,
Rubber Infant Swing

Anchors: 2

Fun Items: Steering Wheel, Telescope

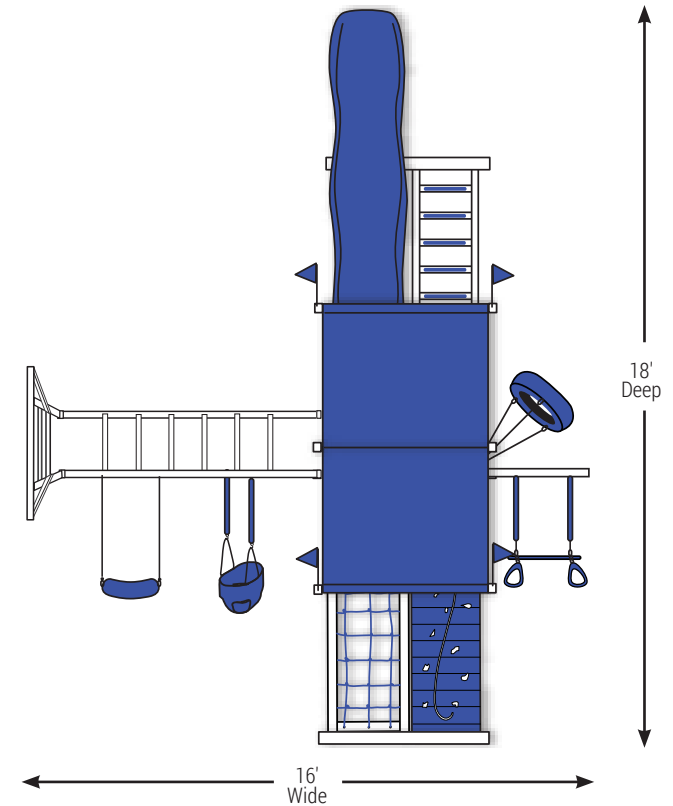



SK-15 Mountain Climber



Size:

19' Wide x 18' Deep x 12' 6" High

Weight:

1,241 lbs.

Space Needed:

31' Wide x 30' Deep

Border Material:

122' Landscape Timber

Recommended Amount of Mulch:

4 Tons Rubber Mulch

16 Cubic Yds. Wood Mulch

Overall Dimensions:

19'w x 18'd x 12' 6"h

Color: White PVC, Blue Accents

Tower: 5x5

Deck Height: 5'

Access: Flat Step Ladder
w/ MC Hand Rail

Roof: 5'x 10' Canvas Roof w/ Flags

Climber: 5' Rock wall for MC Leg,
Cargo Net for MC Leg

Slide: 10' Avalanche Slide

Swing Beam: 3 Position Climber, 1
Position Extension Arm

Swings: Trapeze, 3 Rope Tire Swing,
Dual Rider, Rubber Infant
Swing, Belt Swing

Anchors: 2

Fun Items: Ships Wheel, Binoculars

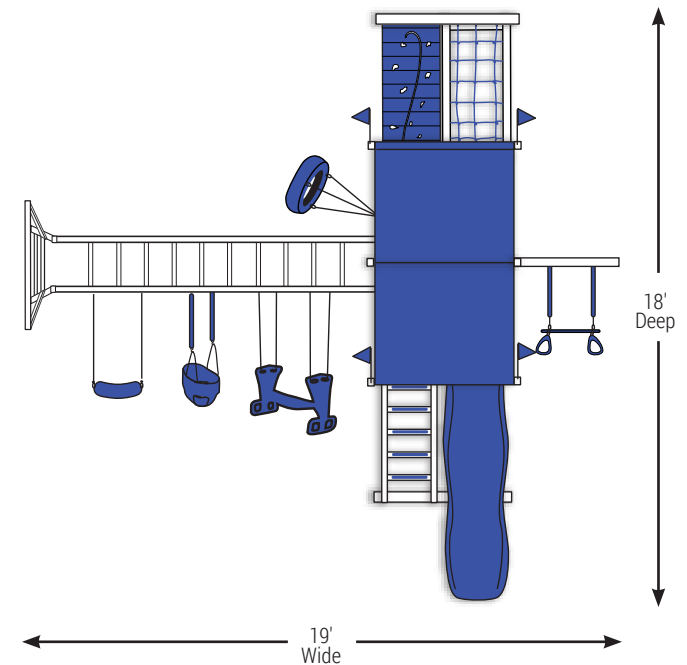



SK-18 Mountain Climber



Size:

24' Wide x 18' Deep x 12' High

Weight:

1,380 lbs.

Space Needed:

36' Wide x 30' Deep

Border Material:

132' Landscape Timber

Recommended Amount of Mulch:

4 Tons Rubber Mulch

20 Cubic Yds. Wood Mulch

Overall Dimensions:

24'w x 18'd x 12'h

Color: Almond PVC,
Red & Yellow Accents

Tower: 5' x 5' Mountain Climber
w/ 7' Landing

Deck Height: 5' w/ 7' Landing

Access: MC Ladder w/ MC Hand Rail

Roof: Gable Roof

Climber: Rock Wall for MC Leg,
Cargo Net for MC Leg

Swing Beam: 4 Position Single Beam

Slides: 10' Avalanche Slide, 7' Turbo
Twister Slide

Swings: Belt Swing, Trapeze,
Hammock Swing, 3-Rope Tire
Swing, Rubber Infant Swing

Anchors: 2

Fun Items: Ship's Wheel, Telescope

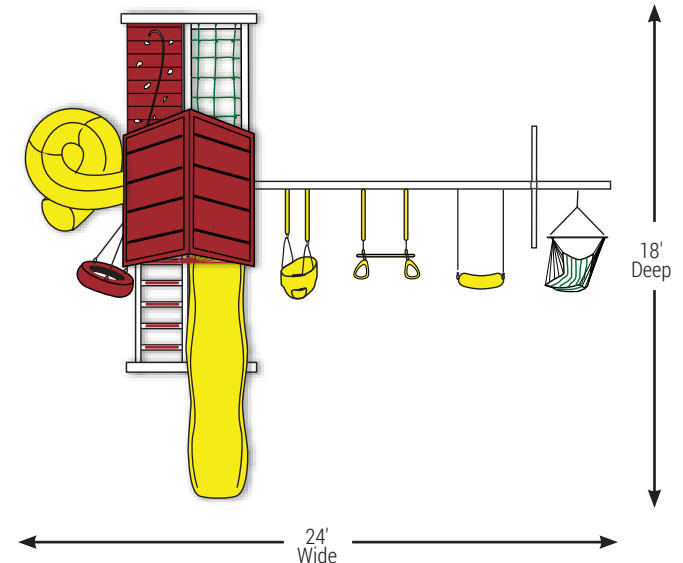



SK-30 Mega Mtn Climber



Size:

24' Wide x 23' Deep x 14' High

Weight:

1,932 lbs.

Space Needed:

36' Wide x 35' Deep

Border Material:

142' Landscape Timber

Recommended Amount of Mulch:

6 Tons Rubber Mulch

30 Cubic Yds. Wood Mulch

Overall Dimensions:

24'w x 23'd x 14'h

Color: Almond PVC,
Red & Yellow Accents

Tower: 5' x 5' Mountain Climber
w/ Mega 7' Deck for MC

Deck Height: 5', 7'

Access: MC Ladder w/ MC Hand Rail

Roof: (2) 5' x 10' Canvas Roofs w/ Flags

Climber: Rock Wall for MC Leg,
Cargo Net for MC Leg

Swing Beam: 4 Position Climber

Slides: 10' Avalanche Slide,
14' Avalanche Slide,
7' Turbo Twister Slide

Swings: Trapeze, Dual Rider, 3-Rope Tire
Swing, Rubber Infant Swing,
Hammock Swing, Belt Swing

Anchors: 2

Fun Items: Steering Wheel,
Megaphone, Telescope

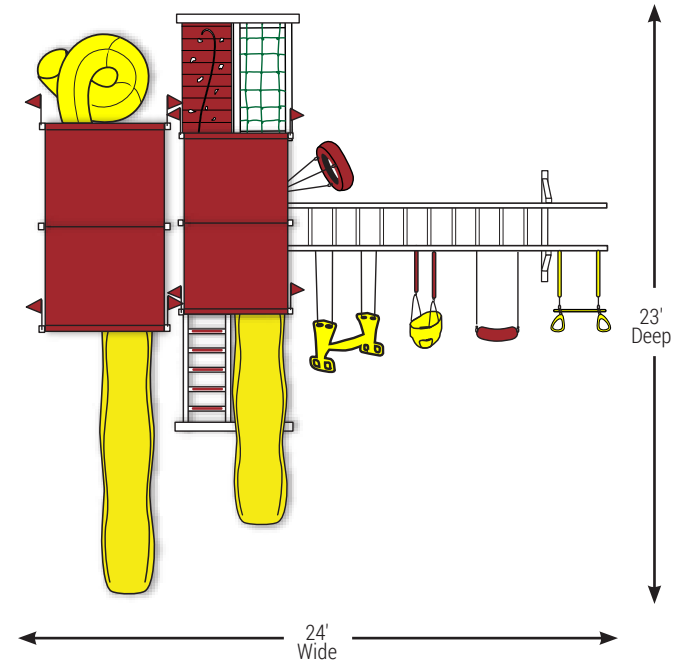



SK-40 Rocky Mtn Climber



Size:

29' Wide x 23' Deep x 14' High

Weight:

2,492 lbs.

Space Needed:

41' Wide x 35' Deep

Border Material:

152' Landscape Timber

Recommended Amount of Mulch:

7 Tons Rubber Mulch

34 Cubic Yds. Wood Mulch

Overall Dimensions:

29'w x 23'd x 14'h

Color: White PVC, Blue Accents

Tower: 5' x 5' Mountain Climber w/
(2) Mega 7' Decks for MC

Deck Height: (2) 7', 5'

Access: MC Ladder w/ MC Hand Rail

Roofs: (3) 5' x 10' Canvas Roofs
w/ Flags

Climber: Rock Wall for MC Leg,
Cargo Net for MC Leg

Swing Beam: 3 Position High Single
Beam

Slides: 10' Avalanche Slide, 14'
Avalanche Slide, 7' Turbo
Twister Slide, 7' Sidewinder Slide

Swings: (2) Belt Swings, Trapeze,
3-Rope Tire Swing

Anchor: 2

Fun Items: Ship's Wheel, Telescope,
Binoculars, Bubble Panel

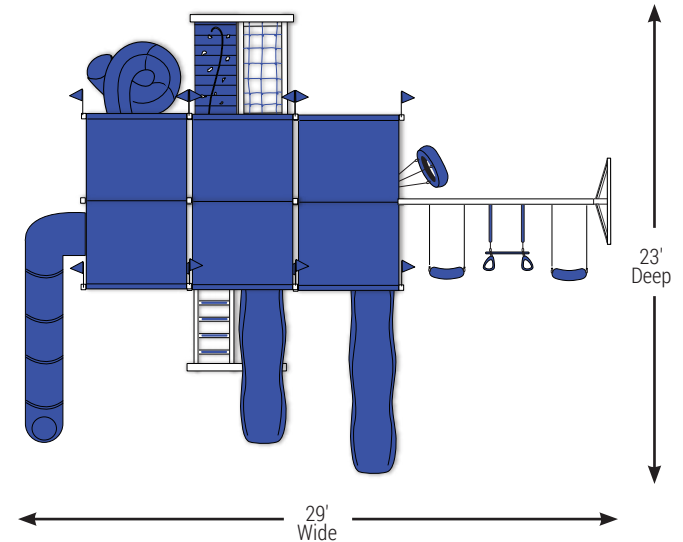

SK-45 Retreat Climber



Size: 41' Wide x 23' Deep x 14' High
Weight: 3,864 lbs.

Space Needed: 53' Wide x 35' Deep
Border Material: 176' Landscape Timber

Recommended Amount of Mulch:
9 Tons Rubber Mulch | 42 Cubic Yds. Wood Mulch



Overall Dimensions:

41'w x 23'd x 14'h

Color: White PVC, Green Accents, White Siding, Weatherwood Shingles

Tower: 5' x 5' Mountain Climber, Mega 7' Deck for MC, 6' x 8' Playhouse Tower, Extra Window w/ Shutters

Deck Height: (2) 5', 7'

Access: Flat Step Access Ladder w/ Access Railing & MC Ladder w/ MC Hand Rail

Roofs: (2) 5' x 5' Vinyl Roofs

Climber: Rock Wall for MC Leg, Cargo Net for MC Leg

Connector: 6'-6" Bridge w/ Rope

Slides: 10' Avalanche Slide, 14' Avalanche Slide, 7' Turbo Twister Slide

Swing Beam: 3 Position High Single Beam, 2 Position Climber

Swings: (2) Belt Swings for High Beam, Baby Swing, Trapeze for High Beam, 3-Rope Tire Swing, Dual Rider

Anchors: 4

Fun Items: Telescope, Binoculars, Tic Tac Toe, 2' x 6' Lemonade Stand

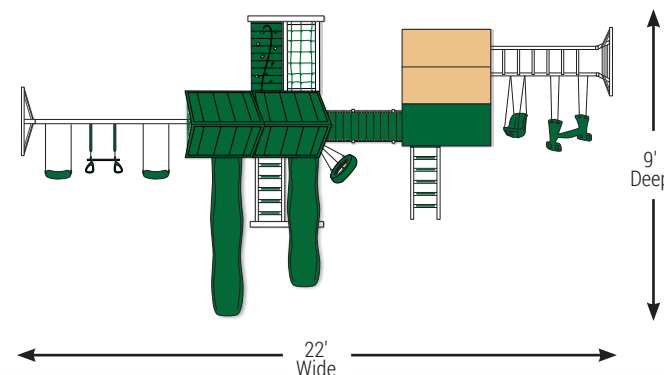



PLAYHOUSE SERIES



“The Playhouse Series allows your children to take their imagination to the next level with a cozy place they can call their own.”

Sami Hill, Assistant Scheduler / CSR

Enjoy a world of make-believe that makes every day different and fun with one of our outdoor playsets!

With room to let imaginations grow, the Playhouse Series gives children swings, slides, and a very special place to call their own. Ideal for creative children with active imaginations and families of all sizes.



C-1 Hideout



Size:

17' Wide x 17' Deep x 10' High

Weight:

1,597 lbs.

Space Needed:

29' Wide x 29' Deep

Border Material:

116' Landscape Timber

Recommended Amount of Mulch:

3 Tons Rubber Mulch
17 Cubic Yds. Wood Mulch

Overall Dimensions:

17'w x 17'd x 10'h

Color: Almond PVC, Green Accents,
Almond Siding, Black Shingles

Tower: 6' x 8' Playhouse Tower,
Extra Window w/ Shutters

Deck Height: 5'

Access: Flat Step Access Ladder
w/ Access Railing

Slide: 10' Avalanche Slide

Swing Beam: 3 Position Climber

Swings: (2) Belt Swings, Trapeze

Anchors: 2

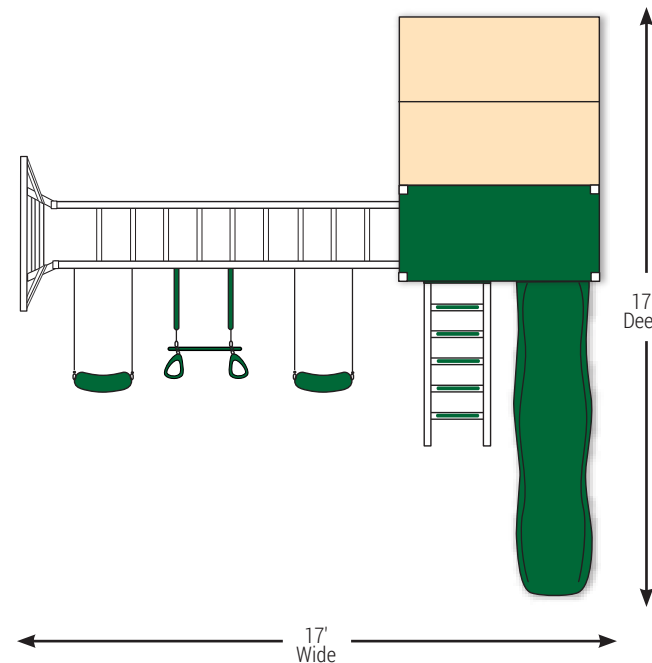



C-2 Turbo Escape



Size:

22' Wide x 20' Deep x 10' High

Weight:

1,835 lbs.

Space Needed:

34' Wide x 32' Deep

Border Material:

132' Landscape Timber

Recommended Amount of Mulch:

4 Tons Rubber Mulch
20 Cubic Yds. Wood Mulch

Overall Dimensions:

22'w x 20'd x 10'h

Color: Almond, Red & Yellow Accents,
Almond Siding, Tan Shingles

Tower: 6' x 8' Playhouse Tower,
Extra 7' Landing, Extra Window
w/ Shutters

Deck Height: 5' w/ 7' Landing

Access: 12' Ramp w/ Rope

Slides: 10' Avalanche Slide,
7' Turbo Twister Slide

Swing Beam: 3 Position Single Beam

Swings: Belt Swing, Trapeze,
Dual Rider
w/ 4-Point Swing Adapter

Anchors: 2

Fun Items: Ship's Wheel

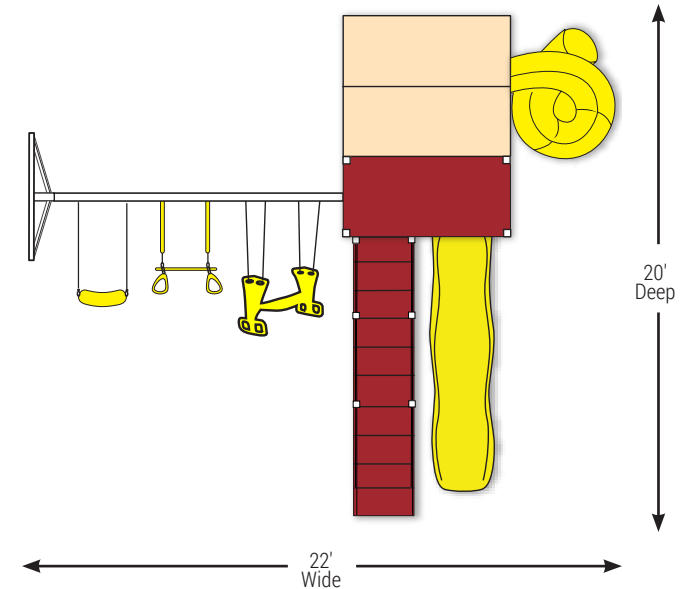



C-3 Tunnel Escape



Size:

38' Wide x 17' Deep x 13' High

Weight:

3,416 lbs.

Space Needed:

50' Wide x 29' Deep

Border Material:

158' Landscape Timber

Recommended Amount of Mulch:

7 Tons Rubber Mulch

34 Cubic Yds. Wood Mulch

Overall Dimensions:

38'w x 17'd x 13'h

Color: White PVC, Green Accents,
White Siding, Weatherwood Shingles

Tower: 5' x 9' Tower, 6' x 8' Playhouse Tower,
Extra 7' Landing, 1 Extra Window
w/ Shutters

Deck Height: (2) 5', 7'

Access: (2) Flat Step Access Ladders
w/ Access Railing

Slides: 10' Avalanche Slide,
7' Turbo Twister Slide

Roof: 5' x 5' Vinyl Roof

Connector: 6'-6" Tower Tunnel

Swings: 4 Rope Tire Swing, Belt Swing,
Trapeze, Dual Rider

Anchors: 2

Swing Beam: 4 Position Climber Beam

Fun Items: Ship's Wheel, Telescope,
Bubble Panel, 5' x 5' Picnic Table

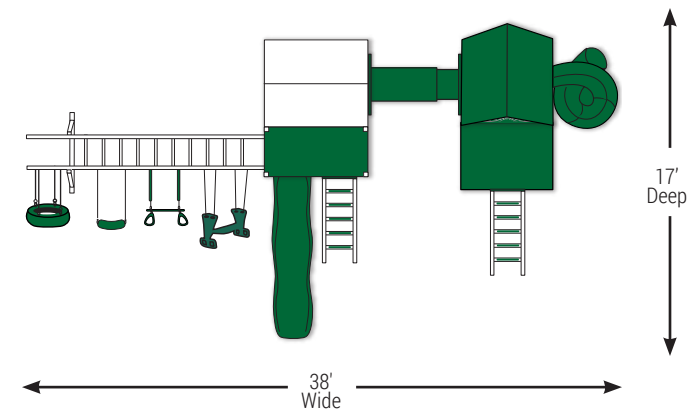



C-4 Hideout



Size:

22' Wide x 20' Deep x 10' High

Weight:

1,625 lbs

Space Needed:

34' Wide x 32' Deep

Border Material:

132' Landscape Timber

Recommended Amount of Mulch:

4 Tons Rubber Mulch

20 Cubic Yds. Wood Mulch

Overall Dimensions:

22'w x 20'd x 10'h

Color: Almond PVC, Green Accents,
Almond Siding, Tan Shingles

Tower: 6' x 8' Playhouse Tower,
Extra Window w/ Shutters

Deck Height: 5'

Access: Flat Step Access Ladder
w/ Access Railing

Slide: 10' Waterfall Slide

Swing Beam: 3 Position Single Beam

Climber: 3' x 5' Rock Wall w/ Rope

Swings: (2) Belt Swings, Trapeze

Anchors: 2

Fun Items: Binoculars

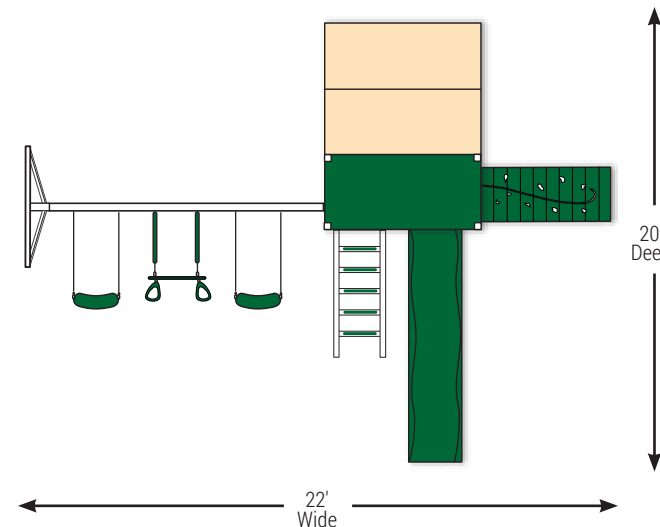

C-5 Castle



Size: 22' Wide x 20' Deep x 10' High
Weight: 2,416 lbs.

Space Needed: 34' Wide x 32' Deep
Border Material: 132' Landscape Timber

Recommended Amount of Mulch:
4 Tons Rubber Mulch | 20 Cubic Yds. Wood Mulch



Overall Dimensions:

22'w x 20'd x 10'h

Color: White PVC, Blue Accents,
White Siding, Black Shingles

Tower: 5' x 5' Tower,
6' x 8' Playhouse Tower,
Extra Window w/ Shutters

Deck Height: (2) 5'

Access: (2) Flat Step Access Ladders
w/ Access Railings

Slide: 10' Waterfall Slide

Roof: 5' x 5' Pyramid Roof

Connector: 8' Bridge w/ Rope

Swings: Belt Swing, Trapeze, Dual Rider

Anchors: 2

Swing Beam: 3 Position Climber

Fun Items: 5' x 6' Picnic Table, Telescope,
Ship's Wheel, Spotlight

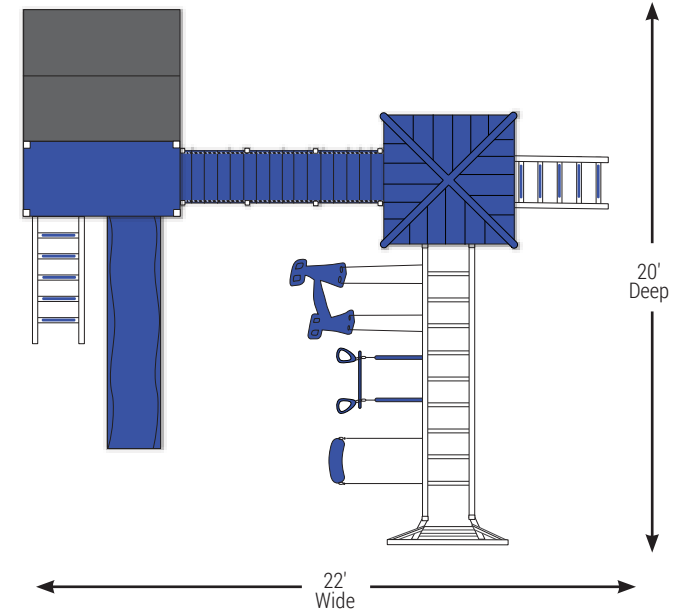

C-8 Bridge Escape



Size: 32' Wide x 18' Deep x 12' High
Weight: 1,735 lbs.

Space Needed: 44' Wide x 30' Deep
Border Material: 148' Landscape Timber

Recommended Amount of Mulch:
5 Tons Rubber Mulch | 25 Cubic Yds. Wood Mulch



Overall Dimensions:

32'w x 18'd x 12'h

Color: Almond PVC, Green Accents,
Almond Siding, Tan Shingles

Tower: 5' x 5' Mountain Climber,
6' x 8' Playhouse Tower,
Extra Window w/ Shutters

Deck Height: (2) 5'

Access: Flat Step Access Ladder
w/ Access Railing,
MC Ladder w/ MC Hand Rail

Connector: 8' Bridge w/ Rope

Roof: 5' x 10' Canvas Roof w/ Flags

Climber: Rock Wall for MC Leg,
Cargo Net for MC Leg

Slide: 10' Avalanche Slide

Swing Beam: 3 Position Single Beam,
2 Position Single Beam

Swings: Belt Swing, Trapeze, Baby Swing,
Fanback Lawn Swing, 3-Rope
Tire Swing

Anchors: 4

Fun Items: Ship's Wheel, (2) Binoculars

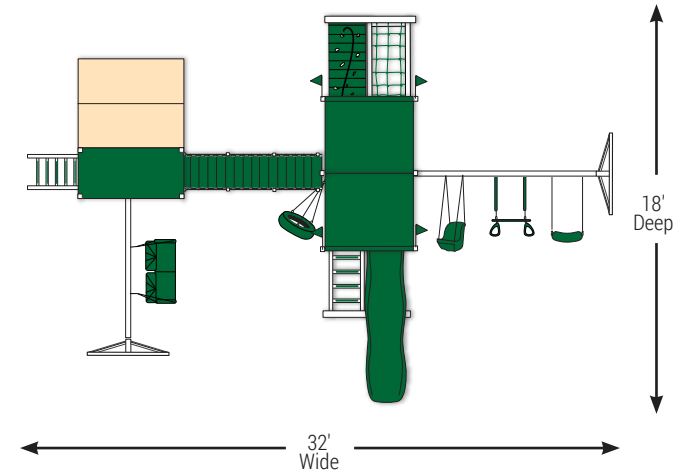



C-10 Hideout



Size:

25' Wide x 24' Deep x 10' High

Weight:

2,447 lbs.

Space Needed:

37' Wide x 36' Deep

Border Material:

146' Landscape Timber

Recommended Amount of Mulch:

5 Tons Rubber Mulch

25 Cubic Yds. Wood Mulch

Overall Dimensions:

25'w x 24'd x 10'h

Color: White PVC, Green Accents, White Siding, Weatherwood Shingles

Tower: 8' x 9' Playhouse w/ (2) 3' x 8' Porches, Extra 7' Landing, Extra Window w/ Shutters

Deck Height: 5' w/ 7' Landing

Access: (2) Flat Step Access Ladders w/ Access Railings

Slides: (2) 10' Avalanche Slides, 7' Turbo Twister Slide

Climber: 3' x 5' Rock Wall w/ Rope

Swing Beam: 4 Position Climber

Swings: (2) Belt Swings, Baby Swing, 3-Rope Tire Swing, Trapeze

Anchors: 2

Fun Items: Ship's Wheel, Binoculars, Tic Tac Toe

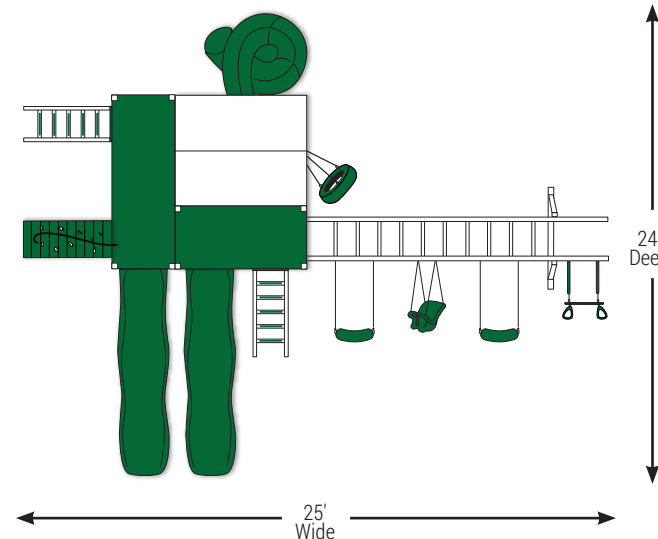

SK-60 Cottage Escape



Size: 42' Wide x 24' Deep x 14' High
Weight: 4,628 lbs.

Space Needed: 54' Wide x 36' Deep
Border Material: 180' Landscape Timber

Recommended Amount of Mulch:
10 Tons Rubber Mulch | 50 Cubic Yds. Wood Mulch



Overall Dimensions:

42'w x 24'd x 14'h

Color: Almond PVC, Red & Yellow Accents, Almond Siding, Weatherwood Shingles

Tower: 5' X 5' Mountain Climber w/ Mega 7' Deck for MC, 8' x 12' Base, 8' x 8' Playhouse w/ 4' x 8' Porch, 2 Extra Windows w/ Shutters

Deck Height: 5', 7'

Access: MC Ladder w/ MC Hand Rail

Slides: 10' Avalanche Slide, 7' Turbo Twister Slide, 14' Avalanche Slide

Roofs: (2) 5' x 10' Canvas Roofs w/ Flags

Connector: 6'-6" Tower Tunnel

Climber: Rock Wall for MC Leg, Cargo Net for MC Leg

Swing Beam: 4 Position Climber

Swings: Belt Swing, Dual Rider, Trapeze, 3-Rope Tire Swing, Baby Swing, Hammock Swing

Anchors: 2

Fun Items: Ship's Wheel, Telescope, Balance Board, Megaphone

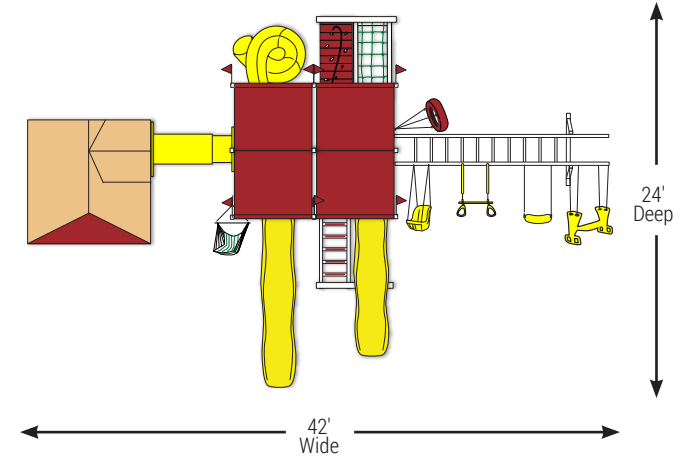



WARRIOR CLIMBING SERIES



“The warrior models are my favorite because each one has a unique design and many challenges for users of all ages. These sets can definitely push you to your limit! They were designed to give users a never ending motivation to find new and creative ways to play. They’re adaptable to the wants and needs of both children and adults alike.”

Cory Martin, Supervisor of Fleet Management

Want to be the next Fitness Warrior?

You will have to train like one!





KC-8 FITNESS TOWER

Size:

25' Wide x 10' Deep x 12' High

Weight:

1,350 lbs.

Space Needed:

37' Wide x 22' Deep

Border Material:

118' Landscape Timber

Recommended Amount of Mulch:

5 Tons Rubber Mulch

23 Cubic Yds. Wood Mulch

Overall Dimensions:

25'w x 10'd x 12'h

Color: Premium Wood Grain,
Green Accents

Tower: 5' x 5' Tower

Deck Height: 5'

Access: Flat Step Access Ladder
w/ Access Railing

Roof: 5' x 5' Vinyl Roof

Slide: 10' Avalanche Slide

Swing Beam: NOC Climber w/
V-Climber and
Salmon Ladder

Anchors: 2

Fun Items: 5' x 5' Picnic Table,
8' Warp Wall

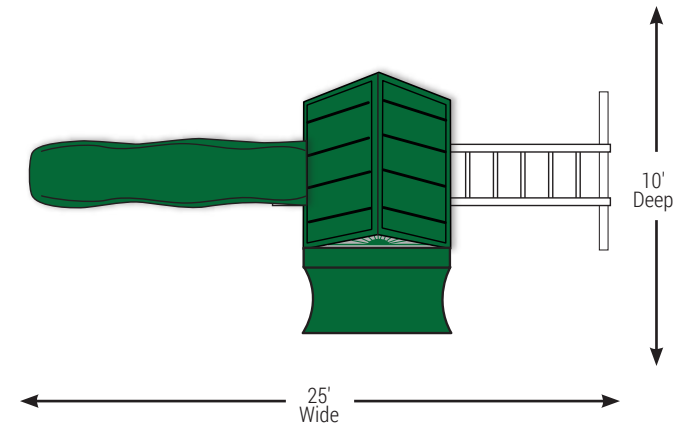

RL-20



Size: 32' Wide x 20' Deep x 10' High
Weight: 2,943 lbs.

Space Needed: 44' Wide x 32' Deep
Border Material: 152' Landscape Timber

Recommended Amount of Mulch:
10 Tons Rubber Mulch | 54 Cubic Yds. Wood Mulch



Overall Dimensions:

32'w x 20'd x 10'h

Color: White PVC, Blue Accents

Towers: 5' x 5' Tower, 5' x 9' Double Tower

Deck Heights: (2) 5', 7'

Access: Flat Step Access Ladder
w/ Access Railing

Climber: 3' x 5' Rock Wall w/ Rope,
5' x 5' Vertical Cargo Net,
5' x 7' Vertical Cargo Net

Slide: 10' Avalanche Slide

Swing Beam: NOC Climber w/ V-Climber,
Salmon Ladder,
3 Position Climber Beam,
3 Position Single High Beam

Anchors: 4

Fun Items: (6) 16' Rock Wall Ropes,
5' Fire Pole, 8' Warp Wall,
10' Warp Wall

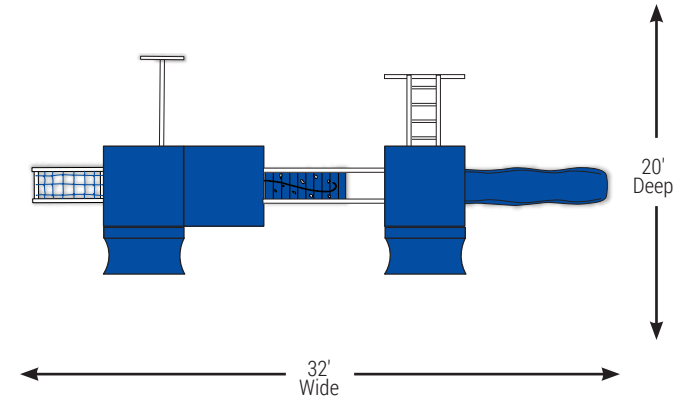

Looking for a couple of stand alone items to **enhance your play?**

Free Standing Swing Frame

11'w x 9'd x 8'h
White PVC, Green Accents | Weight: 207 lbs.



Space Needed: 23' Wide x 21' Deep
Border Material: 88' Landscape Timber
Recommended Amount of Mulch:
2 Tons Rubber Mulch | 10 Cubic Yds. Wood Mulch

Swing Beam: 3 Position Single Beam,
Extra end for Free Standing Single Beam
Swings: (3) Belt Swings
Anchors: 4



Free Standing Items



Hammock With Stand

190" w x 48" d x 45" h:
Tan Palm Tree Swing & Metal Frame
Weight: 56 lbs.



Fan Back Lawn Swing Set

190" w x 48" d x 45" h
Weight 460 lbs.

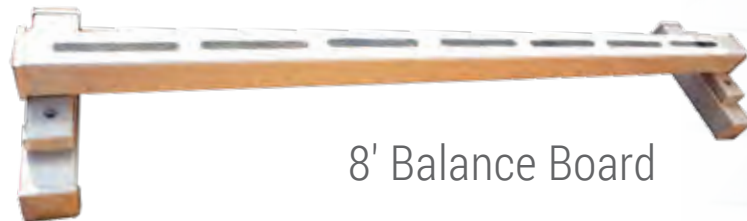
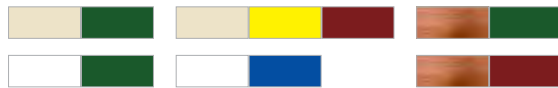

8' Balance Board

1' w x 8' d x 12" h
White or Almond | Weight: 60 lbs.

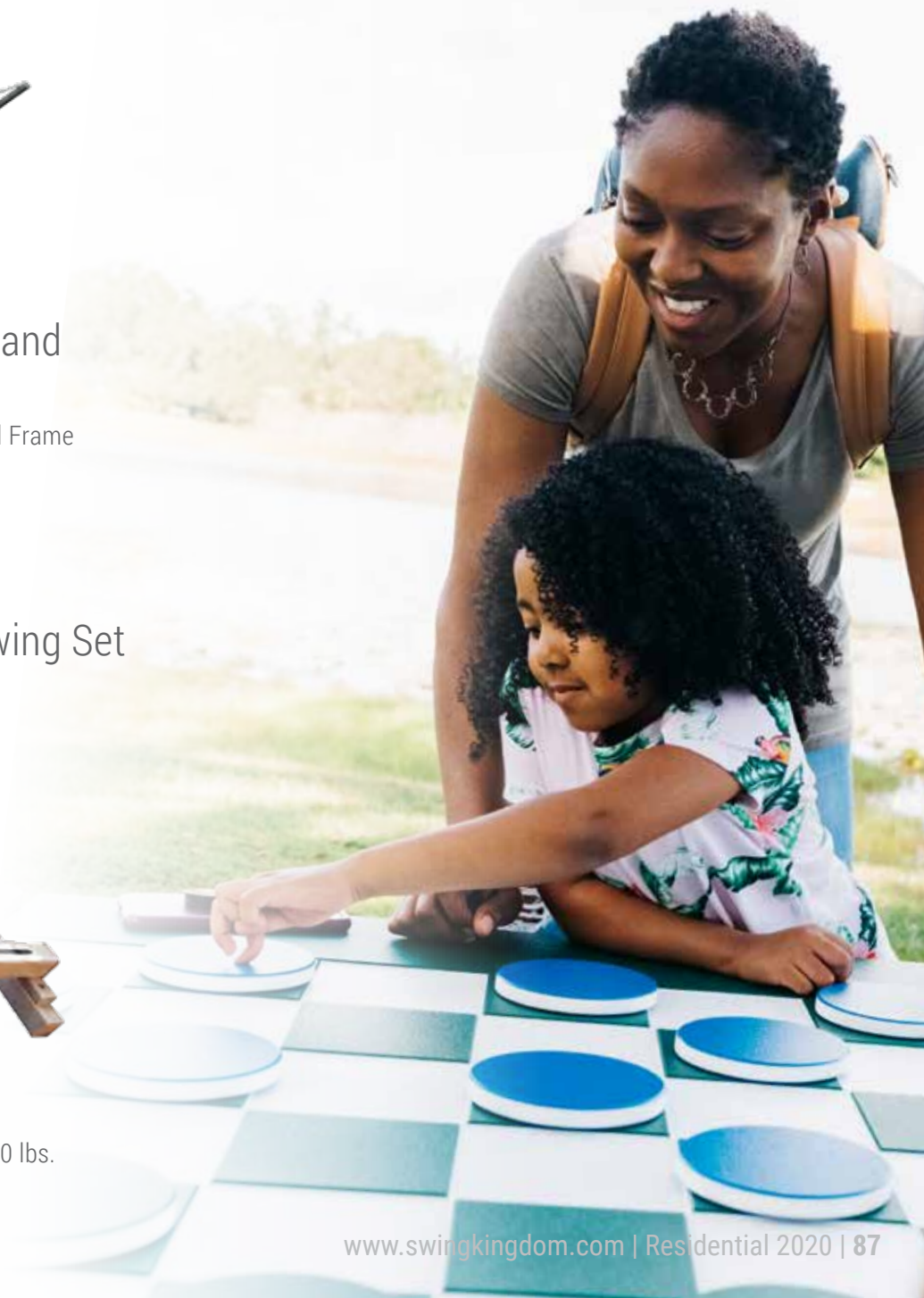

Create your own playset!

Help design your family's unique playset. It's fast and easy. Simply click on the balloons to add and remove play features. You can use this feature from our website or your mobile device.

1. Download the app today.
2. Use the balloons to add, remove or change products, dream, create and define your swing set.
3. Send your unique design to our builders.
4. We will make your playset a reality, bring it to your home and set it up in your yard.
5. Start PLAYING!



Play-a-neers

Swing Kingdom Play-a-neers refers to remarkable people of all sizes and ages and from all cultures. Play-a-neers are those who build on to the Swing Kingdom legacy of creating family memories. We pride ourselves in being pioneers of PLAY through our creative innovation.

The name "Play-a-neer" combines play with engineer, creating the remarkable term that brings fun and construction together to make a dream into reality and a memory everlasting.

The extraordinary value Play-a-neers add to our expanding circle of fun comes from the children, parents, and Swing Kingdom team members who dream, design, and build the magic that is our products.



Color Options



Almond & Green
(Standard Color)



Wood Grain & Red
(Premium Color Upcharge)



White & Green
(Standard Color)



Almond, Yellow & Red
(Standard Color)



Wood Grain & Green
(Premium Color Upcharge)



White & Blue
(Standard Color)



Tower Options



2' x 2' Tower



4' x 4' Tower



3' x 5' Tower



5' x 5' Tower



4' x 8' Double



5' x 9' Double



5' x 9' Double with
Jungle Bar Tower



SK-3
Mountain Climber



Mountain Climber



Mega Mountain Climber



Rocky Mountain Climber



6' x 8' Playhouse Tower



8' x 9' Playhouse Tower
with (2) 3' x 8' Porches



8' x 8' Playhouse Cottage
with 4' x 8' Porch

Playhouse Options

Vinyl Siding Colors



* Colors May Vary

Shingle Colors

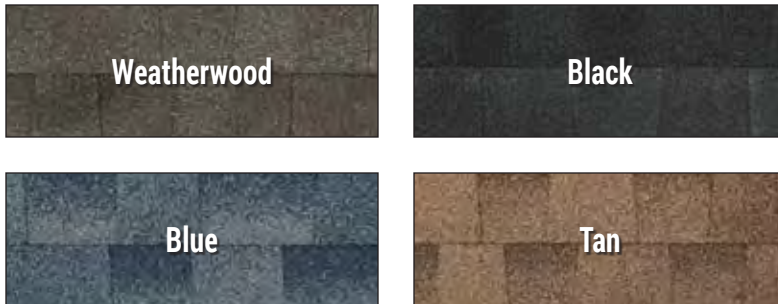

Safety Options

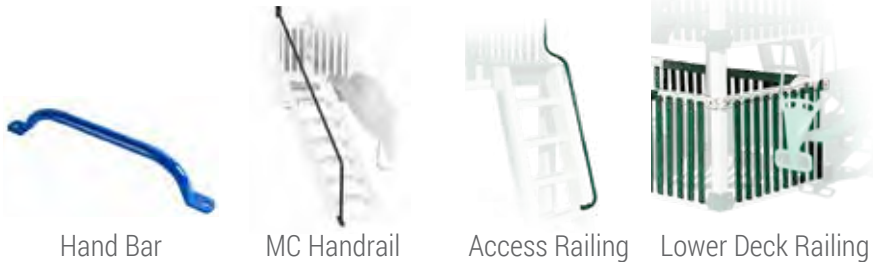

Hand Bar

MC Handrail

Access Railing

Lower Deck Railing

Access Options



Flat Step Access Ladder
w/ Access Railing & Non-Skid Strips



12' Ramp w/Rope
(Also Available With Rails)

Add a Second Tower with a Connector or Swing Beam



Bridge with Rails
6'-6", 8', 9'



Bridge with Rope
6'-6", 8', 9'-9"



Tower Tunnel
6'-6" or 9'-9"

Roof Style



Pyramid Roof
4' x 4' or 5' x 5'



Vinyl Roof
4' x 4' or 5' x 5'



Double Vinyl Roof
5' x 9'



Gable Roof
4' x 4' or 5' x 5'



Canvas Roof
(Use for Mountain Climber Series and 5' x 5' Tower)

Climber Options



Rock Wall
3' x 7'



Rock Wall
3' x 5'



Cargo Net
4' x 5'



Warp Wall
8', 10', 12'

Slide Options

All Slides Available in:



10' Waterfall Slide
(5' Deck)



5' Turbo Twister Slide
(5' Deck)



3' Tunnel Express Slide
(3' Deck)



3' Sidewinder Slide
(3' Deck)



5' Tunnel Express Slide
(5' Deck)



5' Sidewinder Slide
(5' Deck)



10' Avalanche Slide
(5' Deck)



7' Turbo Twister Slide
(7' Deck)



7' Tunnel Express Slide
(7' Deck)



7' Sidewinder Slide
(7' Deck)



14' Avalanche Slide
(7' Deck)



9' Turbo Twister Slide
(9' Deck)



9' Tunnel Express Slide
(9' Deck)



9' Sidewinder Slide
(9' Deck)

Swing Beam Options

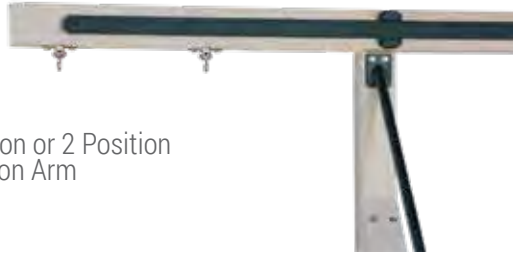

1 Position or 2 Position
Extension Arm



4 Position Single Beam 14' Long
(also available in Single High Beam)



Tower Mounting Ladder



2 Position Single Beam
8' Long



2 Position Climber Beam
8' Long



3 Position Single Beam 10'6" Long
(also available in Single High Beam)



3 Position Climber Beam
10'6" Long



4 Position Climber Beam
14' Long

Swings



Belt Swing



Trapeze



Rubber Infant Swing



Baby Swing



Adaptive Swing



Hammock Swing



Surf Swing



Web Swing





Spring Swing



Cyclone Disc



Buoy Ball



Trapeze Buoy Ball Combo



4-Point Swing Adapter



Uni Rider



Dual Rider



2-Rope Tire Swing



Tire Swing Ropes



3-Rope Tire Swing with Swivel



Tire Swing Ropes



4-Rope Tire Swing



Tire Swing Ropes

Fun Items



Megaphone



Binoculars



Spotlight



Telescope



Bubble Panel



Bubble Tunnel



Kingdom Clock Panel



(Front)

(Back)

Fire Truck Activity Panel
(36 x 30)



ABC Activity Panel
(36" x 30")



Water Cannon



Water Slide Adapter



Swing Beam Water Mister



QB Challenge



Buzzer Beater Hoops



Steering Wheel



Ship's Wheel



Custom Sign

Olivia's Getaway

Custom Name Plate



Fire Pole
5' or 7' Deck



Kingdom Konnect 5



Checkers Game Table



TicTacToe



Clubhouse Walls
5' w x 5' h x 5' d | 5' w x 7' h x 5' d
(Must have Lower Decking)



Lemonade Stand with 2 Stools
2' x 4' | 2' x 5' | 2' x 6'



Picnic Table
4' x 4', 4' x 5' | 5' x 5', 5' x 6'



Sandbox Cover
3' x 5' | 4' x 4' | 4' x 8' | 5' x 5' | 5' x 9' | 6' x 8' | 8' x 9'

Finishing Touches

Landscape Borders



Standard Style Timber (Brown) 4'L x 6''h



Stone Style Timber (Tan) 3'-4''L x 8''h



Stone Style Timber (Gray) 3'-4''L x 8''h

Rubber Mulch



Swing Kingdom rubber mulch can provide extra shock absorption for when kids fall or stumble while at play. With proper installation and adequate depth (around six inches), a rubber mulch surface will give up to 16 feet of critical fall height protection compared to gravel or wood mulch. It can cushion many mishaps and help your child avoid fractures, brain trauma, and other playground-related injuries.

Swing Kingdom rubber mulch has been proven time and again to be the best rubber playground mulch and protection surface. Its main benefits include:

- Unmatched shock absorbency.
- Significant reduction of playground injuries - creates safer playgrounds.
- Non-toxic.

- Minimal maintenance.
- Will not attract insects or rodents.
- Stands up to extreme weather conditions.
- Exceptional longevity.
- Won't dirty up kids' clothing, skin, and hair.
- Cost-effective long-term option to regular playground infills.
- Recommended by the consumer product safety commission to use as playground surface.
- Up to 60% savings versus engineered wood fiber or wood mulch in playground application.
- Requires up to 50% less material than wood mulch.
- Does not float, absorb water or blow away.
- All our products are proudly made in the USA, and are GSA, ASTM, and IPEMA certified.

Wood Mulch (EWF)



- Offers the right amount of cushioning for the most intense of children's play. This includes running, jumping and tumbling, as well as those unfortunate trips and spills that can't be avoided but can be serious if the ground is too hard.
- When installed correctly, our wood fiber safety surfacing allows excellent water drainage. This makes it an excellent playground surface in all types of climates and locations, without having to worry about water pooling and saturation.
- Little maintenance is required with our wood fiber products. They are meant to be installed and enjoyed, and give years of trouble-free service. Aside from some basic raking and topping off, our customers enjoy hassle-free use of our wood mulch playgrounds.
- We have engineered our wood fiber products to be not only resistant, but also attractive. The natural wood fiber looks great with little fading or darkening over time, and provides a harmonious appearance for any setting, rural or urban.
- Green attributes include local raw material extraction, processing and manufacturing, to reduce the carbon footprint related to transportation. Pre-consumer recovered content also means you're helping avoid waste going to landfills.
- Excellent traction and grip characteristics
- Fast drainage to avoid water pooling
- Deep shock absorption for safer play
- Unbeatable durability and wear resistance
- Cost-saving accessories that decrease maintenance costs
- Excellent value that fits your budget
- Pools of water may discourage children from playing
- Standing water can attract bugs, flies and water-borne illnesses
- Puddles can freeze in cold climates, making play dangerous
- Water buildup can cause mold and bacterial growth
- Pooling of water can deteriorate wood play surfaces over time



Playground Turf

- Drains quickly after rainfall for quicker return to play
- Natural look and feel provides visual appeal
- Low maintenance – no watering or mowing!
- Cooler surface temperature compared to other surfaces
- Does not hide dangerous foreign objects
- Does not get in the eyes, mouths or hair of children
- Does not scatter onto walkways and cause tripping or slipping hazards
- Maintain a uniform impact resistance even in high traffic areas - do not get displaced like loose fill surfacing options
- Maintain effectiveness even in high humidity and cold temperature
- Do not support microbial growth - can even include an antimicrobial infill for an added level of protection against bacteria, mold and mildew









Turf Cushion

- Meets ASTM F1292 requirements for up to a 12' fall height
- Reduces allergic reactions caused by grass
- Dries quickly, allowing children to play immediately following rain
- Consistent HIC safety ratings
- Eliminates constant maintenance of loose fill surfacing



As a general rule, unitary surfaces tend to outperform loose fill materials on every criteria aside from the time and cost to install.



Material Type	Material	 Safety Certified	 Cleanliness	 Maintenance	 Accessibility	 Aesthetic	 Install Cost	 Lifetime Cost
Unitary	Synthetic Grass Systems							
Unitary	Poured in Place							
Loose-Fill	Rubber Mulch							
Loose-Fill	Engineered Wood Fiber							



Thank you...

We want to thank you for choosing Swing Kingdom playsets to enhance your backyard and provide your children with the safest playset possible. We're sure you'll appreciate the value and convenience of a non-splintering, low maintenance playset that your children will enjoy for years. Our goal is to provide unmatched safety and comfort in an innovative playset design that encourages active play. Unlike wood, our vinyl playsets will remain smooth to the touch. The innovative SLIP RESISTANT SURFACE is non-splintering, making it safe to play on day after day. The nontoxic, nonabsorbent vinyl material does not require the maintenance time and harsh chemical treatments that are necessary for wooden playsets. In addition, we use stainless steel hardware for extra strength. We value your business. As a Swing Kingdom customer, you can always expect an excellent product along with the very best service we can provide!

Limited Lifetime Warranty 20 Year & 5 Year

Subject to ordinary residential use and proper installation by a certified SK installer, Swing Kingdom warrants to the original purchaser at the original installation address, that the structural components of the playground systems, such as the PVC plastic lumber and wood components are covered by a 20-year warranty. In addition all canopies, slides, metal components, swings and accessories are warranted for 5 years from date of original purchase.

Swing Kingdom's products are not warranted as being suitable for a particular purpose. The suitability of the product is for the purchaser to determine. This warranty does not cover normal wear and tear, failure to properly maintain the product, or damage resulting from misuse or abuse of the product, additionally any acts of nature such as lightning, storms, hurricanes, tornados, earthquakes or any extreme weather conditions. Also any alteration, addition or relocation of the product will void this warranty.

Swing Kingdom reserves the right to deny any claim if the playset or product does not have a product registration on file prior to the claim being submitted. If a product registration is not submitted within 45 days of initial installation, a \$99 registration fee will apply to register the play set and utilize the warranty. Swing Kingdom reserves the right to examine photographs and/or physical evidence of the product claimed to be defective, and to recover product prior to any warranty claims. All products returned for inspection must be sent freight prepaid. In the event of a defect covered by these warranties, Swing Kingdom will remedy the defect within a reasonable time. The remedy will consist of repair or replacement of the defective piece unless it is not practical. Then Swing Kingdom will reimburse the original purchaser for the value of the defective piece. (All freight cost of replacement parts are not covered under the warranty and will be the purchaser responsibility to cover).

Adult supervision is recommended while enjoying your play system.

For safety and comfort reasons, Swing Kingdom reserves the right to make design & construction changes without notice.





CONTACT US AT:

©2020 Swing Kingdom, LLC. All rights reserved.
No part of this catalog may be reproduced
in any form without the prior expressed
written authorization of Swing Kingdom, LLC.